

MID-CENTURY MODERN

Eames. Jacobsen. Noguchi. Say the names and mid-century classics such as the egg chair appear. In deco, over-sized deco pulls, saucer knobs, or supple yet subtle curves define clean, asymmetrical statement pieces. Materials include golds, brushed brass and Lucite. The color palette features vivid shades of turquoise, turmeric and orange.







Mid-Century Modern

BY HÄFELE

NEW

	Finish	Material	A	C	Item No.	SRP/pc.
1	brushed nickel	Zinc	74	64	106.69.100	\$6.96
2	black brushed nickel	Zinc	74	64	106.69.320	\$7.04
3	brushed nickel	Zinc	170	160	106.69.101	\$10.26
4	black brushed nickel	Zinc	170	160	106.69.321	\$10.34
5	brushed nickel	Zinc	329	320	106.69.102	\$20.72
6	black brushed nickel	Zinc	329	320	106.69.322	\$21.14
7	antique brushed brass	Zinc	-	-	106.70.131	\$7.66
8	polished chrome	Zinc	-	-	106.70.130	\$7.20
9	brushed nickel	Zinc	-	-	106.70.135	\$10.10
10	matt gold	Zinc	-	-	106.70.136	\$11.06

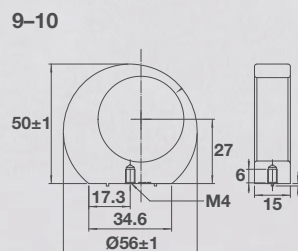
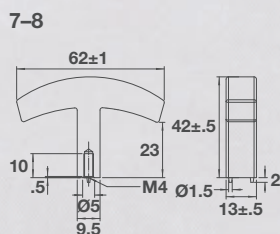
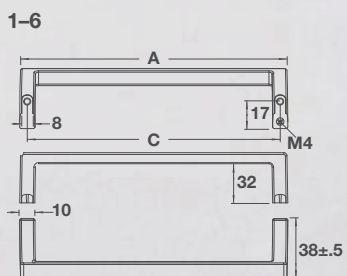



Arco NEW

BY HÄFELE

	Finish	Material	A	C	Item No.	SRP/pc.
1	polished chrome	Zinc	-	-	118.68.204	\$8.31
2	stainless steel	Zinc	-	-	118.68.104	\$8.47
3	stainless steel	Zinc	170	160	103.30.106	\$8.45
4	stainless steel	Zinc	138	128	103.30.105	\$7.67
5	polished chrome	Zinc	170	160	103.30.206	\$8.23
6	polished chrome	Zinc	138	128	103.30.205	\$7.41
7	polished chrome	Zinc	-	-	110.35.390	\$7.26
8	stainless steel	Zinc	-	-	110.35.392	\$7.42

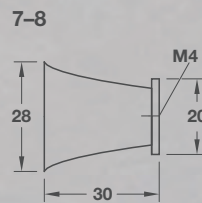
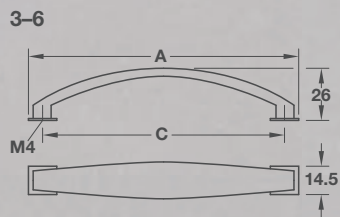
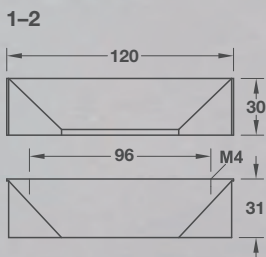

Dimensions in mm unless otherwise noted.



Arco **NEW**
BY HÄFELE

	Finish	Material	A	C	Item No.	SRP/pc.
1	polished nickel	Zinc	-	-	118.68.704	\$8.47
2	matt black	Zinc	-	-	118.68.804	\$7.06
3	polished nickel	Zinc	170	160	103.30.706	\$8.51
4	polished nickel	Zinc	138	128	103.30.705	\$7.69
5	matt black	Zinc	170	160	103.30.806	\$6.85
6	matt black	Zinc	138	128	103.30.805	\$6.21
7	polished nickel	Zinc	-	-	110.35.391	\$7.16
8	matt black	Zinc	-	-	110.35.393	\$6.14

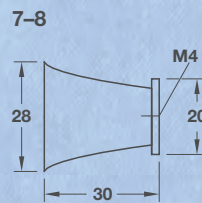
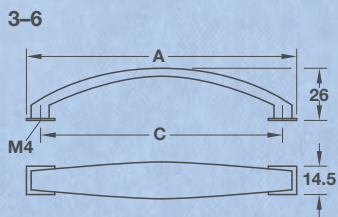
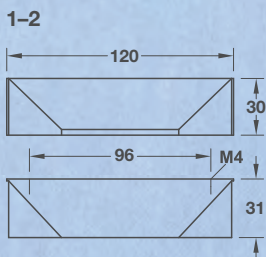



Mid-Century Modern

BY HÄFELE

	Finish	Material	Item No.	SRP/pc.
1	polished chrome	Zinc	110.34.227	\$12.08
2	brushed nickel	Zinc	110.34.627	\$14.17
3	matt black	Zinc	110.34.327	\$12.01
4	matt black	Zinc	110.34.355	\$15.79
5	brushed nickel	Zinc	110.34.655	\$15.27
6	polished chrome	Zinc	110.34.255	\$13.69
7	polished chrome	Zinc	110.35.271	\$3.31
8	matt black	Zinc	110.35.371	\$2.57

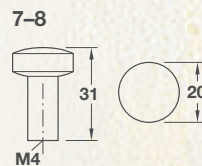
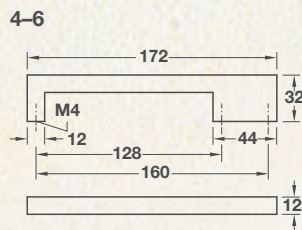
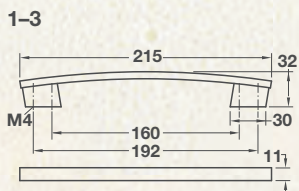



Mid-Century Modern

BY HÄFELE - 4-5

	Finish	Material	A	C	Item No.	SRP/pc.
1	polished chrome	Zinc	-	-	104.33.200	\$19.80
2	matt nickel	Zinc	-	-	104.33.600	\$14.05
3	dark oil-rubbed bronze	Zinc	-	-	104.33.330	\$17.79
4	oil-rubbed bronze	Zinc	148	128	106.61.043	\$11.25
5	oil-rubbed bronze	Zinc	180	160	106.61.044	\$12.38

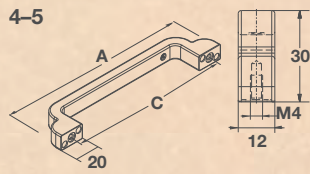
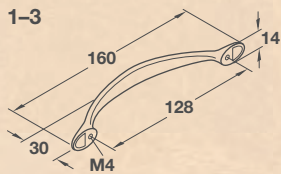



Mid-Century Modern

BY HÄFELE - 5-6

	Finish	Material	A	B	C	D	Item No.	SRP/pc.
1	stainless steel look	Zinc	192	17	128	24	104.80.002	\$21.96
2	matt nickel	Zinc	230	20	160	26	104.80.600	\$18.15
3	matt nickel	Zinc	-	-	-	-	109.57.602	\$33.42
4	matt chrome	Zinc	-	-	-	-	109.80.401	\$17.95
5	matt black	Zinc	-	-	-	-	106.69.501	\$7.58
6	brushed brass	Zinc	-	-	-	-	106.69.502	\$7.95
7	matt nickel	Brass	-	-	-	-	136.76.610	\$11.26
8	satin nickel	Zinc	-	-	-	-	105.49.620	\$18.54
9	brushed nickel	Brass	-	-	-	-	161.16.600	\$39.08
10	matt aluminum	Zinc	-	-	-	-	107.40.902	\$18.84

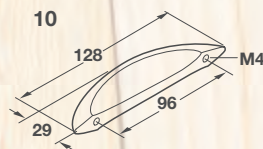
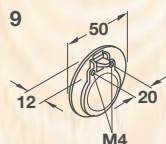
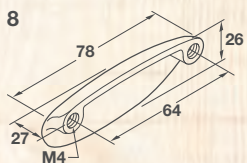
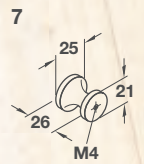
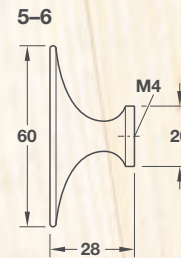
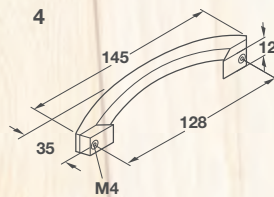
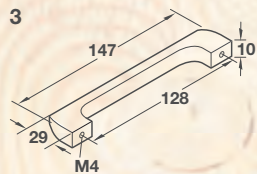
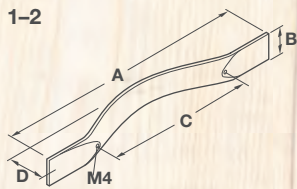

Dimensions in mm unless otherwise noted. Prices subject to change.



Aeon



	Finish	Material	A	C	Item No.	SRP/pc.
1	graphite	Zinc	127	96	110.22.050	\$11.39
2	matt gold	Zinc	127	96	110.22.080	\$20.36
3	graphite	Zinc	191	160	110.22.086	\$18.31
4	matt gold	Zinc	191	160	110.22.081	\$26.90
5	graphite	Zinc	351	320	110.22.089	\$26.52
6	matt gold	Zinc	351	320	110.22.082	\$35.08

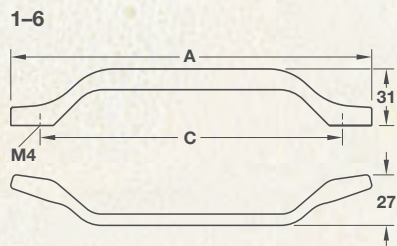

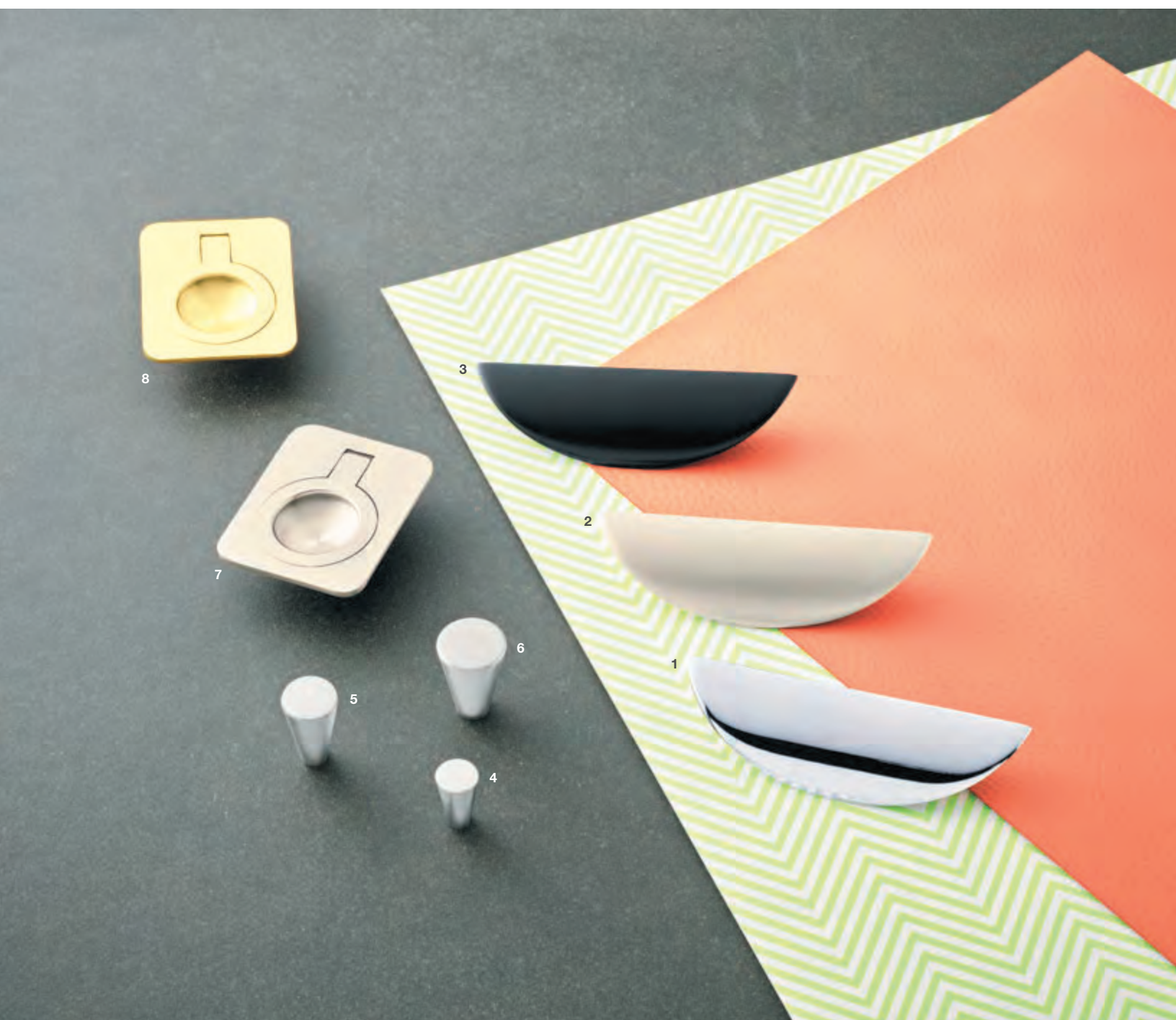

Mid-Century Modern



	Finish	Material	A	B	C	Item No.	SRP/pc.
1	polished chrome	Zinc	-	-	-	104.66.200	\$17.99
2	matt nickel	Zinc	-	-	-	104.66.600	\$16.26
3	black matt	Zinc	-	-	-	104.66.300	\$17.13
4	matt	Stainless Steel	12	20	7	155.01.510	\$17.62
5	matt	Stainless Steel	16	26	9	155.01.511	\$19.78
6	matt	Stainless Steel	20	28	11	155.01.512	\$21.66
7	brushed nickel	Brass	-	-	-	155.01.571	\$54.88
8	brushed	Brass	-	-	-	155.01.572	\$47.10

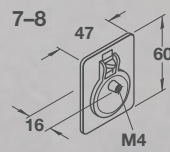
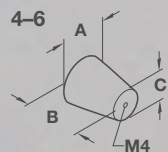
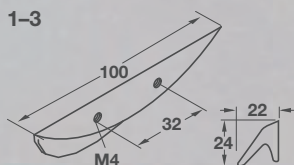



Mid-Century Modern



Finish

- 1 matt
- 2 matt
- 3 matt nickel
- 4 matt nickel
- 5 polished chrome
- 6 brushed
- 7 polished chrome
- 8 matt nickel

Material

- 1 Stainless Steel
- 2 Stainless Steel
- 3 Zinc
- 4 Zinc
- 5 Brass
- 6 Brass
- 7 Brass
- 8 Brass

Item No.

- 134.83.602
- 134.82.605
- 155.00.570
- 105.26.600
- 136.76.205
- 137.21.500
- 136.06.212
- 136.06.614

SRP/pc.

- \$7.97
- \$6.96
- \$2.14
- \$4.80
- \$6.98
- \$5.93
- \$4.95
- \$4.59

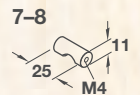
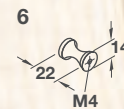
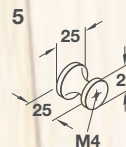
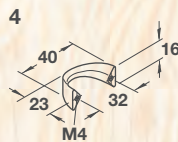
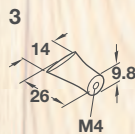
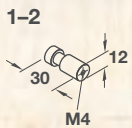



Avignon

	Finish	Material	A	C	Item No.	SRP/pc.
1	satin nickel	Zinc	336	288	108.78.017	\$55.38
2	polished chrome	Zinc	336	288	108.78.217	\$47.66
3	satin nickel	Zinc	203	160	108.78.013	\$37.44
4	polished chrome	Zinc	203	160	108.78.213	\$28.32

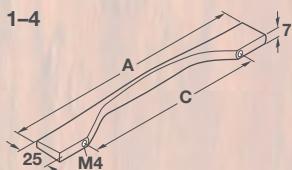

Dimensions in mm unless otherwise noted. Prices subject to change.



Mid-Century Modern

	Finish	Material	A	C	Item No.	SRP/pc.
1	polished chrome	Zinc	130	96	108.76.231	\$27.88
2	polished chrome	Zinc	164	128	108.76.232	\$33.74
3	polished chrome	Zinc	194	160	108.76.233	\$35.40
4	black matt	Zinc	194	160	108.76.240	\$30.22
5	black matt	Zinc	130	96	108.76.245	\$25.66
6	black matt	Zinc	164	128	108.76.250	\$29.44

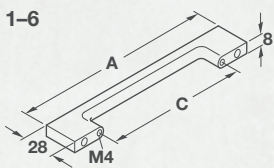

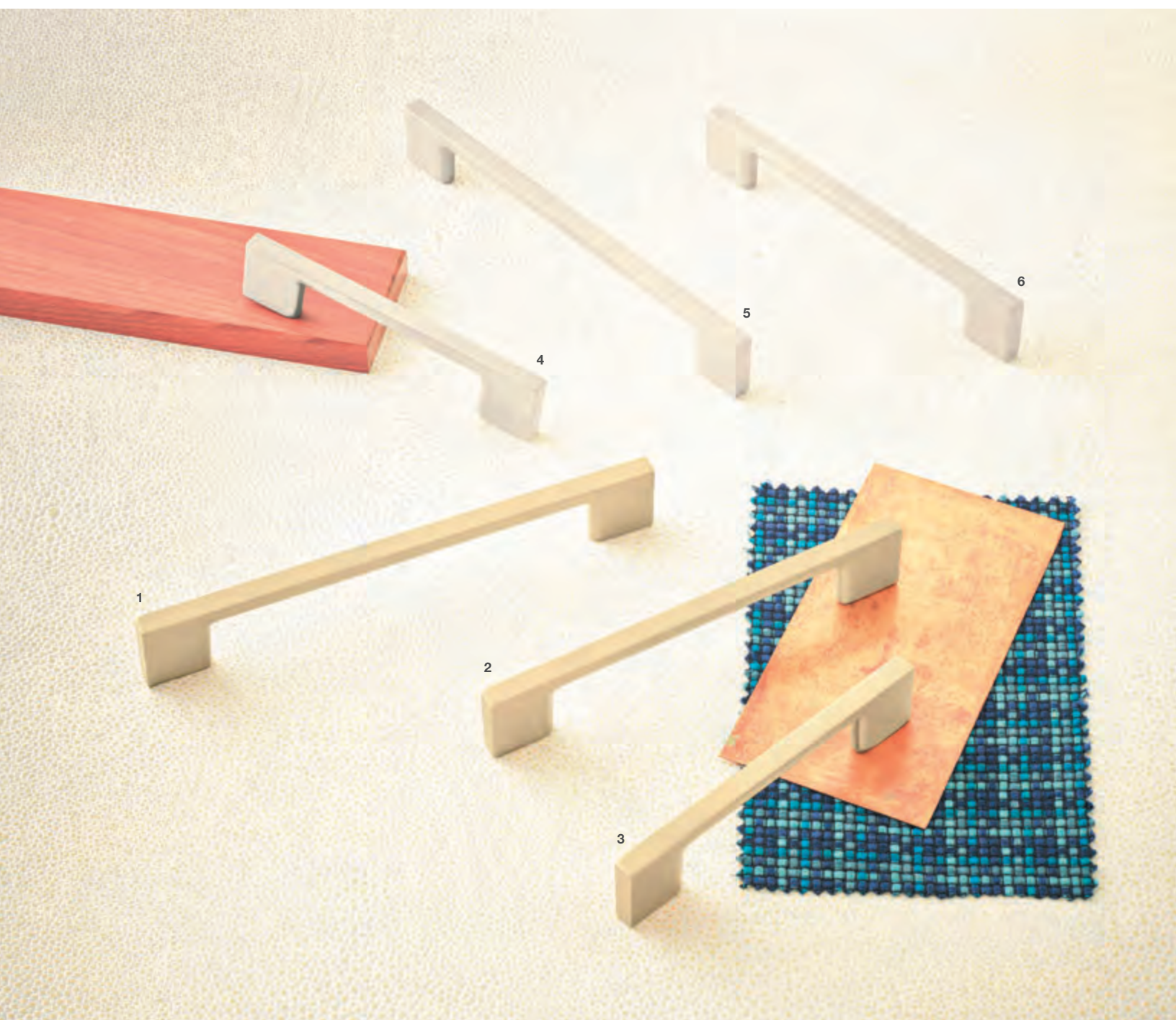

Mid-Century Modern

	Finish	Material	A	C	Item No.	SRP/pc.
1	matt gold	Zinc	194	160	108.76.241	\$33.34
2	matt gold	Zinc	164	128	108.76.251	\$26.84
3	matt gold	Zinc	130	96	108.76.246	\$25.20
4	satin nickel	Zinc	130	96	108.76.731	\$30.96
5	satin nickel	Zinc	194	160	108.76.733	\$38.70
6	satin nickel	Zinc	164	128	108.76.732	\$34.60

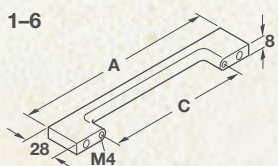



Mid-Century Modern

	Finish	Material	Item No.	SRP/pc.
1	stainless steel look	Zinc	102.71.959	\$16.47
2	matt nickel	Zinc	105.63.600	\$27.76
3	matt black	Zinc	105.63.300	\$17.07
4	matt black	Zinc	102.81.320	\$21.80

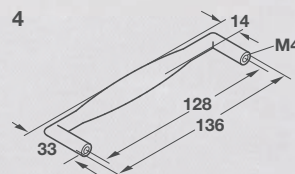
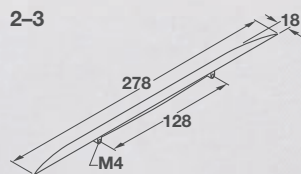
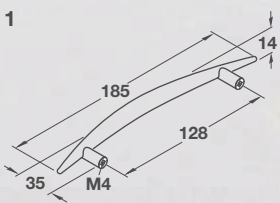



Aventura **NEW**

	Finish	Material	Item No.	SRP/pc.
1	satin nickel	Zinc	102.47.300	\$16.05
2	polished chrome	Zinc	102.47.301	\$17.28
3	matt gold	Zinc	102.47.302	\$17.28
4	matt black	Zinc	102.47.303	\$14.81
5	satin nickel	Zinc	133.57.610	\$12.35
6	polished chrome	Zinc	133.57.611	\$13.58
7	matt gold	Zinc	133.57.612	\$13.58
8	matt black	Zinc	133.57.613	\$12.35

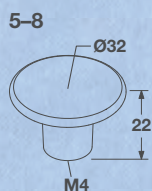
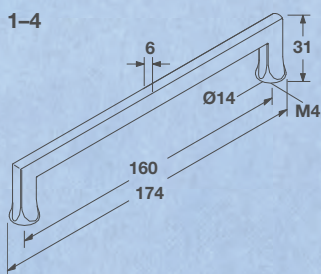

Dimensions in mm unless otherwise noted. Prices subject to change.

MODERN

Clean lines. Hard angles. Modern design conjures the function-focused unity of the Bauhaus and the simple light colors of the Scandinavian schools. Predominantly neutral yet modern design surprises with a pop of color. In deco finishes, modern style features stainless steel, nickel or black finishes.







Modern NEW

BY HÄFELE

	Finish	Material	A	B	C	Item No.	SRP/pc.
1	black brushed nickel	Zinc	180	25	128	106.69.190	\$11.64
2	brushed nickel	Zinc	180	25	128	106.69.170	\$11.46
3	black brushed nickel	Zinc	373	28	320	106.69.191	\$26.64
4	brushed nickel	Zinc	373	28	320	106.69.171	\$26.10
5	brushed nickel	Zinc	212	25	160	106.69.010	\$11.42
6	black brushed nickel	Zinc	212	25	160	106.69.011	\$11.68
7	matt gold	Zinc	right	-	-	101.69.504	\$12.81
8	matt gold	Zinc	left	-	-	101.69.505	\$12.81
9	matt black	Zinc	right	-	-	101.69.510	\$10.38
10	matt black	Zinc	left	-	-	101.69.511	\$10.38

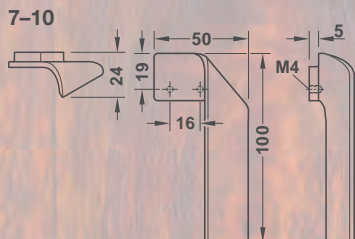
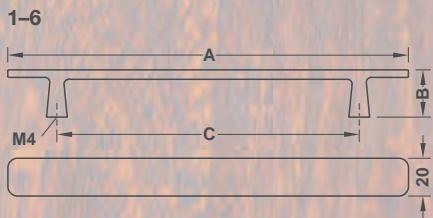



Zurich NEW

BY HÄFELE

	Finish	Material	A	C	Item No.	SRP/pc.
1	polished chrome	Zinc	83	64	155.01.992	\$5.34
2	polished chrome	Zinc	147	128	155.02.002	\$9.98
3	polished chrome	Zinc	184	160	155.02.012	\$11.39
4	matt nickel	Zinc	83	64	155.01.991	\$5.11
5	matt nickel	Zinc	147	128	155.02.001	\$9.57
6	matt nickel	Zinc	184	160	155.02.011	\$10.94
7	brushed brass	Zinc	184	160	155.02.013	\$12.68
8	brushed brass	Zinc	147	128	155.02.003	\$10.92
9	brushed brass	Zinc	83	64	155.01.993	\$6.15

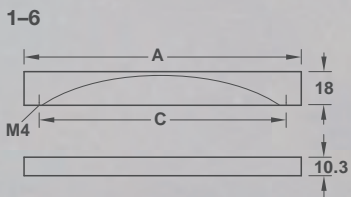



Manhattan NEW

BY HÄFELE

	Finish	Material	A	C	Item No.	SRP/pc.
1	brushed brass	Aluminum	200	128	155.02.351	\$13.99
2	matt black	Aluminum	200	128	155.02.321	\$14.60
3	silver anodized	Aluminum	200	128	155.02.331	\$12.99
4	stainless steel	Aluminum	200	128	155.02.341	\$14.62
5	brushed brass	Aluminum	100	64	155.02.350	\$10.58
6	matt black	Aluminum	100	64	155.02.320	\$10.58
7	silver anodized	Aluminum	100	64	155.02.330	\$9.73
8	stainless steel	Aluminum	100	64	155.02.340	\$10.58

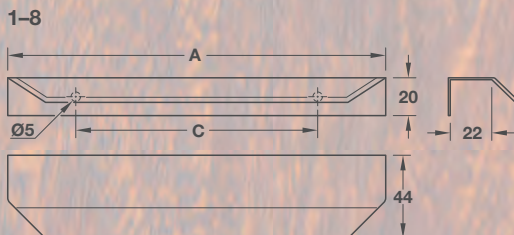

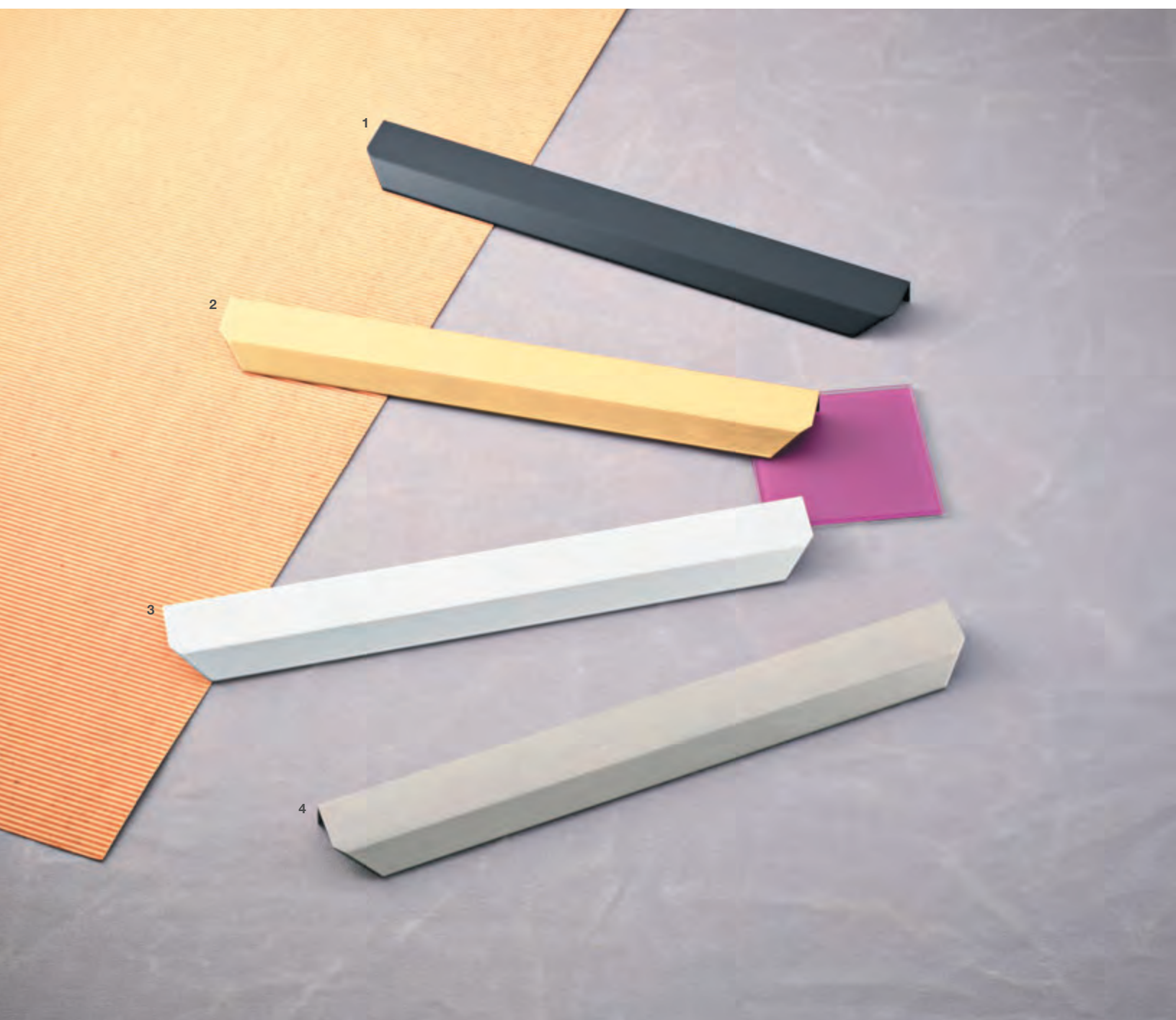

Manhattan NEW

BY HÄFELE

	Finish	Material	A	C	Item No.	SRP/pc.
1	matt black	Aluminum	350	256	155.02.322	\$22.60
2	brushed brass	Aluminum	350	256	155.02.352	\$22.46
3	silver anodized	Aluminum	350	256	155.02.332	\$19.81
4	stainless steel	Aluminum	350	256	155.02.342	\$21.60

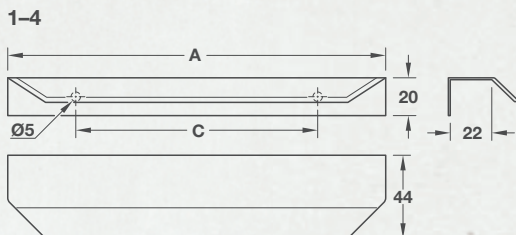

Dimensions in mm unless otherwise noted. Prices subject to change.



Cube

BY HÄFELE

	Finish	Material	A	C	Item No.	SRP/pc.
1	matt black	Aluminum	206	192	106.70.042	\$20.40
2	brushed nickel	Aluminum	206	192	106.70.032	\$24.32
3	matt black	Aluminum	174	160	106.70.041	\$18.30
4	brushed nickel	Aluminum	174	160	106.70.031	\$22.36
5	matt black	Aluminum	-	-	106.70.082	\$8.22
6	brushed nickel	Aluminum	-	-	106.70.081	\$10.19
7	matt black	Aluminum	142	128	106.70.040	\$16.46
8	brushed nickel	Aluminum	142	128	106.70.030	\$19.36
9	matt black	Aluminum	-	-	106.70.072	\$4.74
10	brushed nickel	Aluminum	-	-	106.70.071	\$5.73

1-4, 7-8

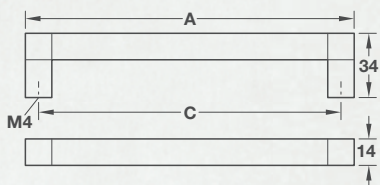

5-6

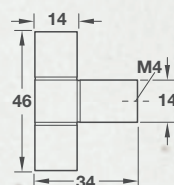

9-10

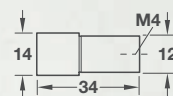



Modern

BY HÄFELE

Finish	Material	A	C	Item No.	SRP/pc.
1 polished chrome	Zinc	148	128	106.69.205	\$20.86
2 polished chrome	Zinc	212	192	106.69.207	\$27.46
3 brushed nickel	Zinc	148	128	106.69.605	\$18.96
4 brushed nickel	Zinc	212	192	106.69.607	\$29.36
5 black matt	Zinc	202	192	110.34.307	\$10.14
6 black matt	Zinc	170	160	110.34.306	\$9.19
7 brushed nickel	Zinc	170	160	110.34.606	\$13.76
8 brushed nickel	Zinc	202	192	110.34.607	\$15.94

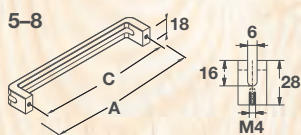
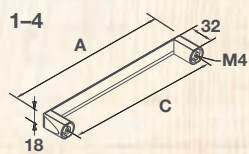

Dimensions in mm unless otherwise noted. Prices subject to change.



Neoteric



	Finish	Material	A	C	Item No.	SRP/pc.
1	matt black	Aluminum	350	256	155.01.831	\$21.50
2	matt black	Aluminum	300	256	155.01.850	\$18.42
3	matt black	Aluminum	800	640	155.01.835	\$40.78
4	matt black	Aluminum	700	640	155.01.854	\$37.78
5	matt black	Aluminum	500	384	155.01.833	\$29.42
6	matt black	Aluminum	400	352	155.01.852	\$24.04
7	matt black	Aluminum	-	-	155.01.870	\$7.97

1, 3, 5

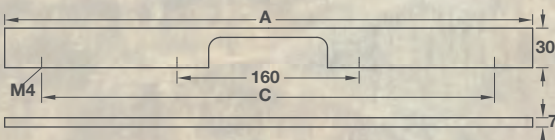

2, 4, 6

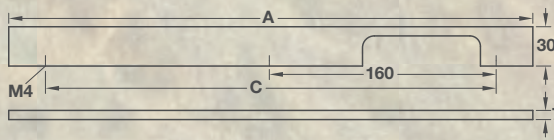

7

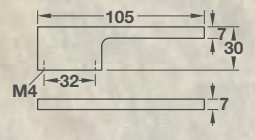

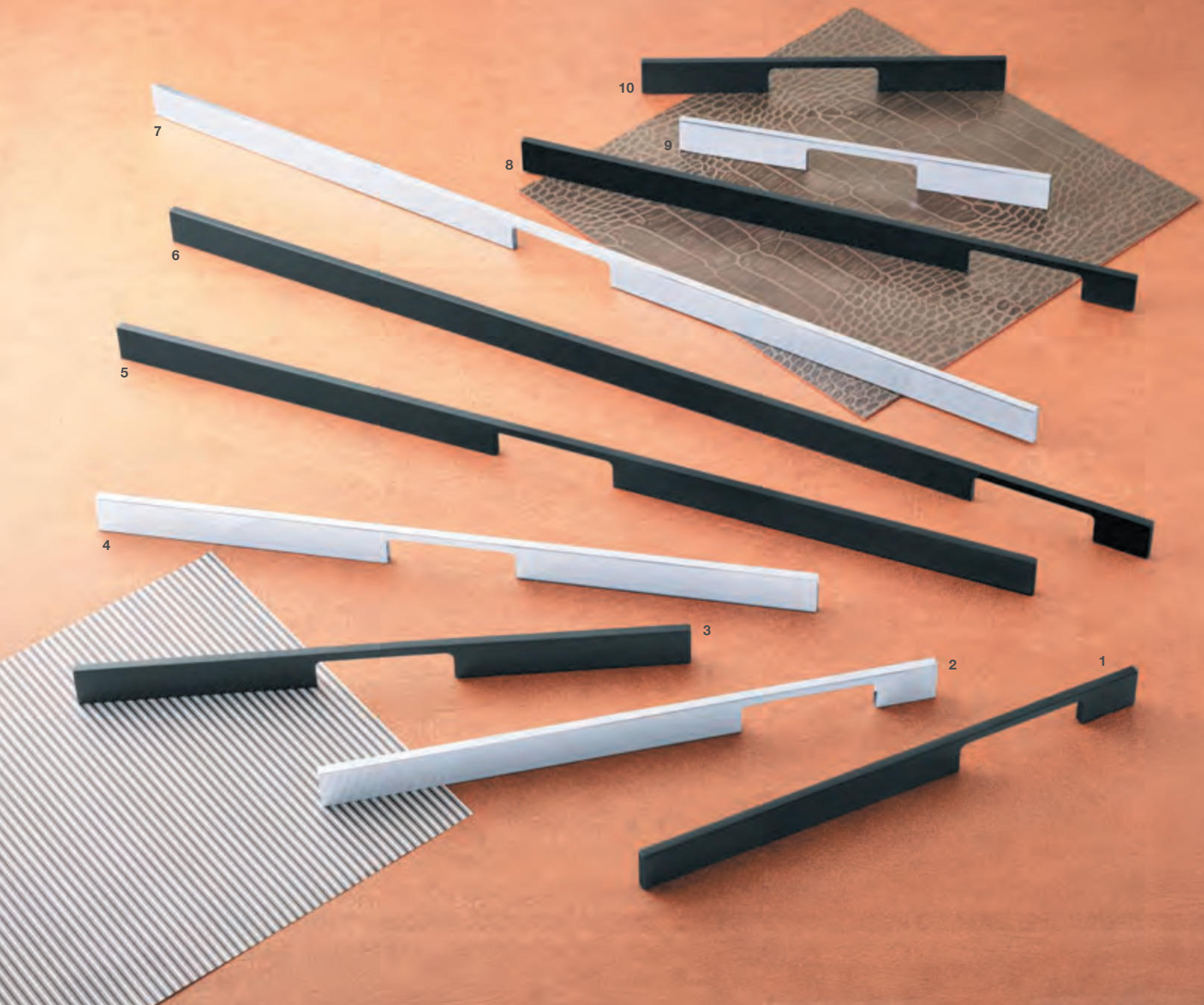

Neoteric



	Finish	Material	A	C	Item No.	SRP/pc.
1	matt black	Aluminum	350	288	155.01.851	\$21.28
2	polished chrome	Aluminum	350	288	155.01.861	\$27.14
3	matt black	Aluminum	400	320	155.01.832	\$24.12
4	polished chrome	Aluminum	500	384	155.01.843	\$37.90
5	matt black	Aluminum	700	560	155.01.834	\$37.64
6	matt black	Aluminum	800	736	155.01.855	\$40.56
7	polished chrome	Aluminum	800	640	155.01.845	\$55.10
8	matt black	Aluminum	500	448	155.01.853	\$29.22
9	polished chrome	Aluminum	300	224	155.01.840	\$23.80
10	matt black	Aluminum	300	224	155.01.830	\$18.63

1-2, 6, 8

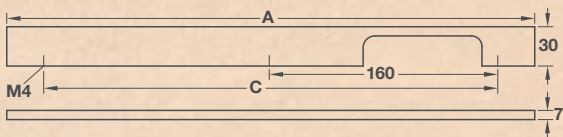

3-5, 7, 9-10

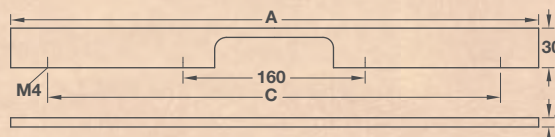



Neoteric



	Finish	Material	A	C	Item No.	SRP/pc.
1	polished chrome	Aluminum	300	256	155.01.860	\$23.56
2	polished chrome	Aluminum	350	256	155.01.841	\$27.34
3	polished chrome	Aluminum	400	352	155.01.862	\$30.82
4	polished chrome	Aluminum	800	736	155.01.865	\$54.92
5	polished chrome	Aluminum	700	560	155.01.844	\$50.98
6	polished chrome	Aluminum	700	640	155.01.864	\$50.92
7	polished chrome	Aluminum	500	448	155.01.863	\$37.82
8	polished chrome	Aluminum	400	320	155.01.842	\$30.86
9	polished chrome	Aluminum	-	-	155.01.871	\$10.11

1, 3-4, 6-7

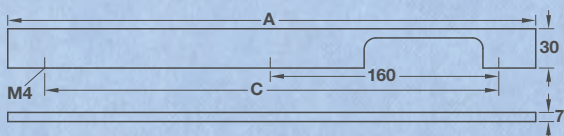

2, 5, 8

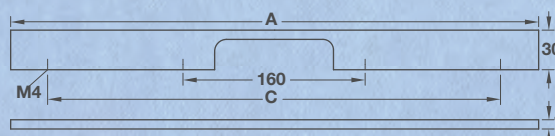

9

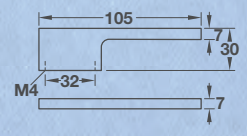

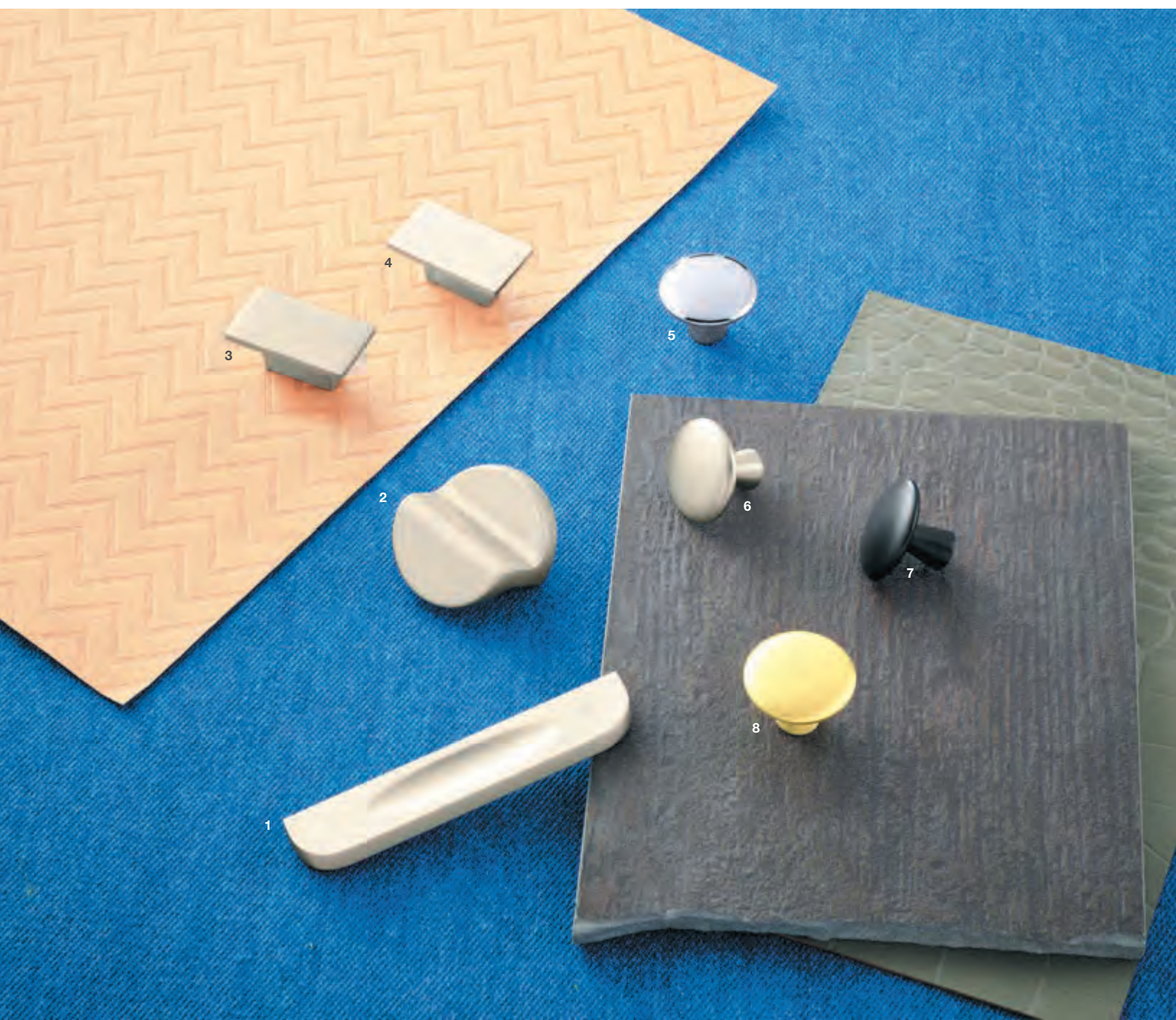

Modern

 3, 5-8

	Finish	Material	Item No.	SRP/pc.
1	matt nickel	Zinc	105.34.602	\$10.22
2	matt nickel	Zinc	106.09.601	\$18.35
3	satin nickel	Zinc	155.00.350	\$2.84
4	polished chrome	Zinc	106.69.280	\$3.35
5	polished chrome	Zinc	155.02.240	\$4.17
6	brushed nickel	Zinc	155.02.241	\$4.29
7	matt black	Zinc	155.02.243	\$3.84
8	brushed brass	Zinc	155.02.242	\$4.14

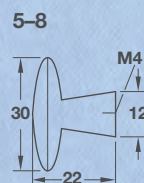
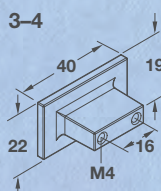
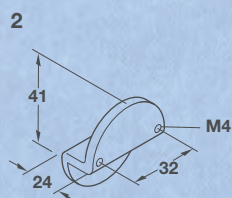
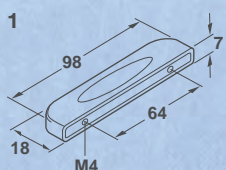

Dimensions in mm unless otherwise noted. Prices subject to change.



Singapore



	Finish	Material	A	C	C1	Item No.	SRP/pc.
1	matt black	Aluminum	200	128	96	155.02.360	\$21.50
2	stainless steel look	Aluminum	200	128	96	110.46.084	\$25.84
3	matt black	Aluminum	400	320	192	155.02.361	\$37.54
4	stainless steel look	Aluminum	400	320	192	110.46.087	\$40.84
5	oil-rubbed bronze	Aluminum	200	128	-	126.45.046	\$18.22
6	stainless steel look	Aluminum	200	128	-	126.14.605	\$16.29
7	silver anodized	Aluminum	200	128	-	126.45.965	\$16.29
8	oil-rubbed bronze	Aluminum	350	256	-	126.45.049	\$28.14
9	stainless steel look	Aluminum	350	256	-	126.14.608	\$24.40
10	silver anodized	Aluminum	350	256	-	126.45.969	\$24.40

1-4

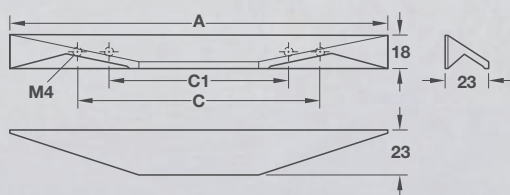

5-10

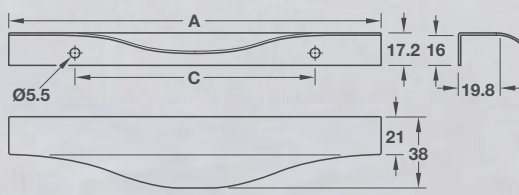



Isabella

	Finish	Material	A	C1	C	Item No.	SRP/pc.
1	matt aluminum	Aluminum	156	96	128	108.94.901	\$48.22
2	matt aluminum	Aluminum	220	128	192	155.00.971	\$52.32
3	matt aluminum	Aluminum	284	160	256	108.94.903	\$55.82
4	matt aluminum	Aluminum	348	192	320	108.94.904	\$58.50
5	matt aluminum	Aluminum	412	224	384	108.94.905	\$63.08
6	matt aluminum	Aluminum	540	288	512	108.94.907	\$65.62
7	matt aluminum	Aluminum	476	256	448	108.94.906	\$65.94

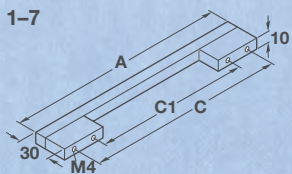

Dimensions in mm unless otherwise noted. Prices subject to change.



Resonance

	Finish	Material	A	C	Item No.	SRP/pc.
1	stainless steel	Aluminum	170	160	112.82.003	\$38.70
2	stainless steel	Aluminum	202	192	112.82.004	\$39.44
3	stainless steel	Aluminum	300	290	112.82.007	\$62.92
4	stainless steel	Aluminum	400	390	112.82.010	\$65.52
5	matt aluminum	Aluminum	170	160	112.82.903	\$35.02
6	matt aluminum	Aluminum	400	390	112.82.910	\$54.30
7	matt aluminum	Aluminum	300	290	112.82.907	\$44.78
8	matt aluminum	Aluminum	202	192	112.82.904	\$43.80

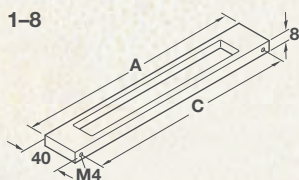

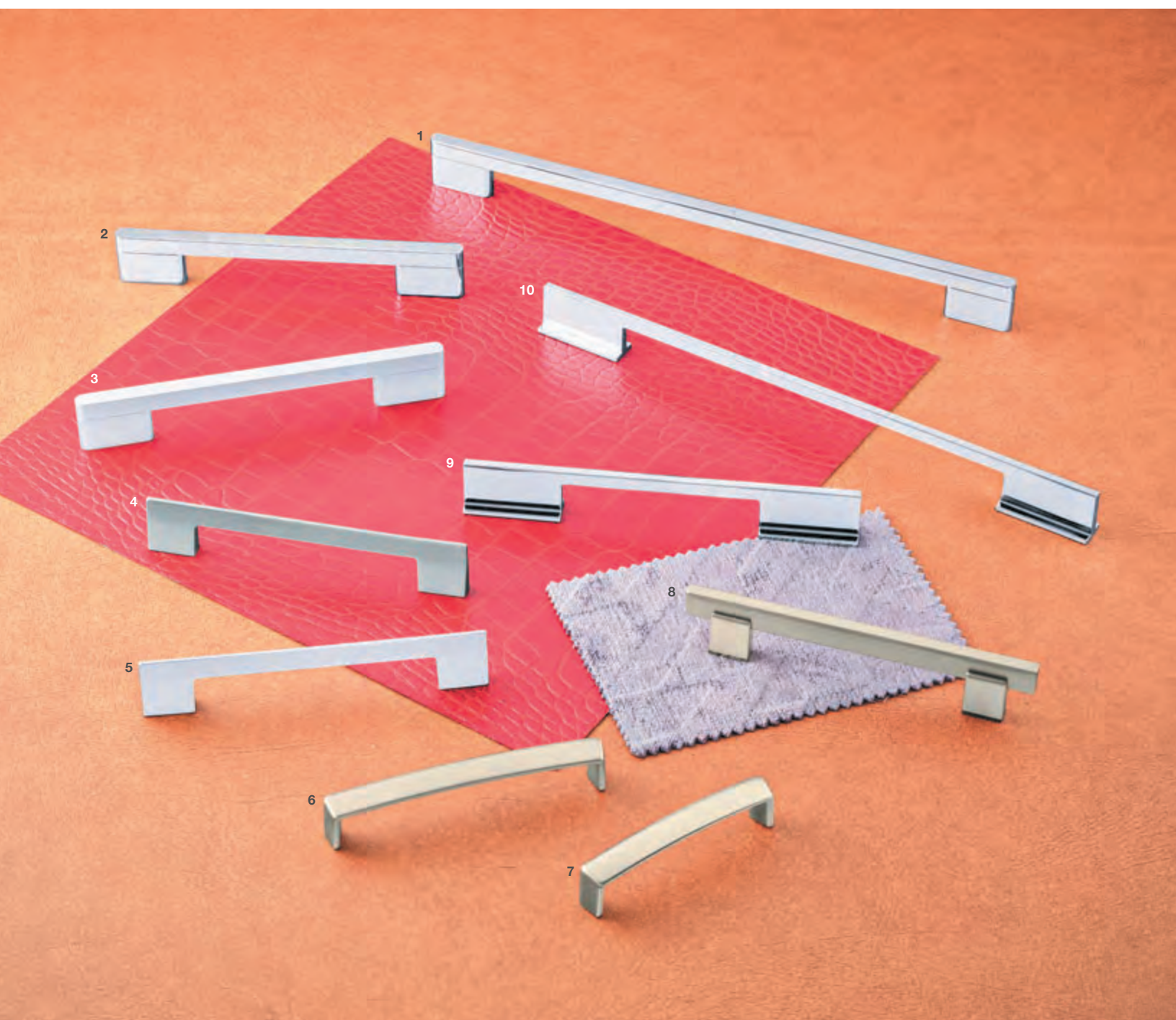

Modern

	Finish	Material	A	C1	C	Item No.	SRP/pc.
1	polished chrome	Aluminum	360	-	320	108.94.228	\$74.06
2	polished chrome	Aluminum	200	-	160	108.94.223	\$57.62
3	matt aluminum	Aluminum	200	-	160	108.94.923	\$35.66
4	stainless steel look	Zinc	-	-	-	111.93.686	\$14.69
5	polished chrome	Zinc	-	-	-	111.93.286	\$14.59
6	satin nickel	Zinc	136	-	128	111.59.625	\$26.38
7	satin nickel	Zinc	104	-	96	111.59.624	\$23.50
8	satin nickel	Zinc	-	-	-	111.24.605	\$36.90
9	polished chrome	Aluminum	206	160	192	112.81.273	\$43.32
10	polished chrome	Aluminum	334	288	320	112.81.278	\$79.06

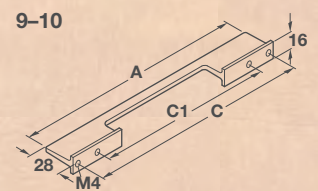
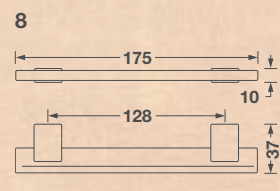
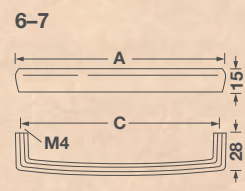
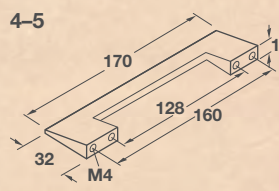
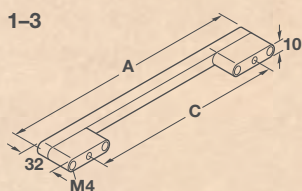

Dimensions in mm unless otherwise noted. Prices subject to change.



Affinity **NEW**

	Finish	Material	A	C	Item No.	SRP/pc.
1	polished chrome	Zinc	264	256	102.47.361	\$46.92
2	polished chrome	Zinc	200	192	102.47.351	\$27.19
3	matt gold	Zinc	264	256	102.47.362	\$46.92
4	matt gold	Zinc	200	192	102.47.352	\$27.19
5	satin nickel	Zinc	200	192	102.47.350	\$27.19
6	satin nickel	Zinc	264	256	102.47.360	\$46.92
7	matt black	Zinc	200	192	102.47.353	\$27.19
8	matt black	Zinc	264	256	102.47.363	\$46.92

Note

Refer to page 260 for matching appliance pulls.

1-12

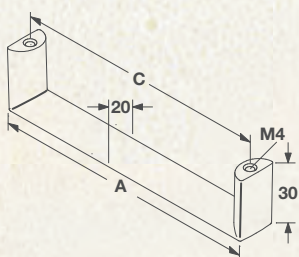



Affinity **NEW**

	Finish	Material	A	B	C	D	Item No.	SRP/pc.
1	satin nickel	Zinc	72	28	64	17	102.47.320	\$17.28
2	satin nickel	Zinc	137	30	128	20	102.47.330	\$23.45
3	satin nickel	Zinc	168	30	160	20	102.47.340	\$24.72
4	matt gold	Zinc	168	30	160	20	102.47.342	\$24.72
5	matt gold	Zinc	137	30	128	20	102.47.332	\$23.45
6	matt gold	Zinc	72	28	64	17	102.47.322	\$17.28
7	matt black	Zinc	72	28	64	17	102.47.323	\$17.28
8	matt black	Zinc	137	30	128	20	102.47.333	\$23.45
9	matt black	Zinc	168	30	160	20	102.47.343	\$24.72
10	polished chrome	Zinc	72	28	64	17	102.47.321	\$17.28
11	polished chrome	Zinc	137	30	128	20	102.47.331	\$23.45
12	polished chrome	Zinc	168	30	160	20	102.47.341	\$24.72

Note

Refer to page 260 for matching appliance pulls.

1-12

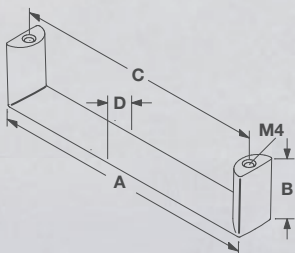

Dimensions in mm unless otherwise noted. Prices subject to change.



Modern *NEW

	Finish	Material	A	C	Item No.	SRP/pc.
1*	matt black	Zinc	–	–	102.47.393	\$19.75
2*	matt gold	Zinc	–	–	102.47.392	\$20.99
3*	satin nickel	Zinc	–	–	102.47.390	\$19.75
4*	polished chrome	Zinc	–	–	102.47.391	\$19.75
5	satin nickel, antimicrobial	Zinc	138	128	116.07.700	\$22.18
6	satin nickel, antimicrobial	Zinc	202	192	116.07.701	\$25.68

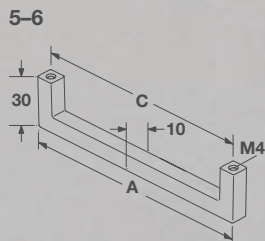
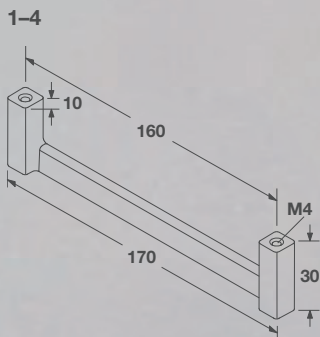



Essential'z

BY AMEROCK

ADA 2-3

	Finish	Material	A	B	C	Item No.	SRP/pc.
1	matt	Stainless Steel	-	-	-	133.50.681	\$26.62
2	matt nickel	Zinc	106	30	96	133.50.276	\$17.42
3	matt nickel	Zinc	170	29	160	133.50.275	\$18.99

Note
Supplied with 1" mounting screws.

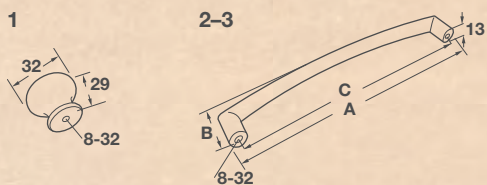

Dimensions in mm unless otherwise noted. Prices subject to change.



Cyprus

BY AMEROCK

	Finish	Material	A	B	C	D	Item No.	SRP/pc.
1	black bronzed	Zinc	167	29	96	13	133.53.109	\$14.23
2	black bronzed	Zinc	133	27	76 (3")	10	133.53.108	\$9.50
3	polished nickel	Zinc	133	27	76 (3")	10	133.53.118	\$9.50
4	polished nickel	Zinc	167	29	96	13	133.53.119	\$14.23
5	black bronzed	Zinc	230	32	160	13	133.53.110	\$22.89
6	polished nickel	Zinc	230	32	160	13	133.53.120	\$22.89
7	black bronzed	Zinc	198	30	128	13	133.53.112	\$17.42
8	polished nickel	Zinc	198	30	128	13	133.53.122	\$17.42

Note

Supplied with 1" mounting screws. Refer to page 262 for matching appliance pulls.

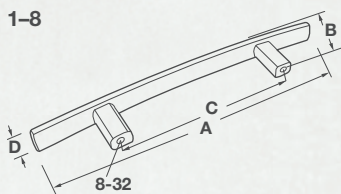



Cyprus

BY AMEROCK

	Finish	Material	A	B	C	D	Item No.	SRP/pc.
1	gold champagne	Zinc	133	27	76 (3")	10	133.53.113	\$9.50
2	gold champagne	Zinc	167	29	96	13	133.53.114	\$14.23
3	gold champagne	Zinc	230	32	160	13	133.53.115	\$22.89
4	gold champagne	Zinc	198	30	128	13	133.53.117	\$17.42
5	satin nickel	Zinc	230	32	160	13	133.50.263	\$20.61
6	satin nickel	Zinc	198	30	128	13	133.50.262	\$17.42
7	satin nickel	Zinc	167	29	96	13	133.50.265	\$14.23
8	satin nickel	Zinc	133	27	76 (3")	10	133.50.264	\$9.50

Note

Supplied with 1" mounting screws. Refer to page 262 for matching appliance pulls.

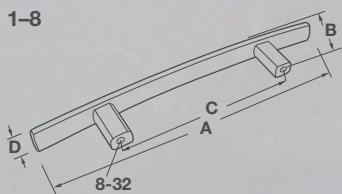

Dimensions in mm unless otherwise noted. Prices subject to change.



Oberon

BY AMEROCK

	Finish	Material	A	B	Item No.	SRP/pc.
1	gold champagne	Zinc	35	30	133.50.618	\$15.84
2	gold champagne	Zinc	44	33	133.50.619	\$18.99
3	gunmetal	Zinc	35	30	133.50.620	\$17.59
4	gunmetal	Zinc	44	33	133.50.621	\$21.11
5	polished nickel	Zinc	44	33	133.50.623	\$18.99
6	polished nickel	Zinc	35	30	133.50.622	\$15.84
7	satin nickel	Zinc	44	33	133.50.625	\$18.99
8	satin nickel	Zinc	35	30	133.50.624	\$15.84

Note
Supplied with 1" mounting screws.

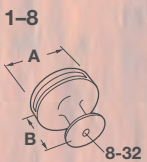



Oberon

BY AMEROCK

	Finish	Material	A	B	Item No.	SRP/pc.
1	polished nickel/frosted	Zinc/Acrylic	44	33	133.50.105	\$24.67
2	gold champagne/frosted	Zinc/Acrylic	44	33	133.50.101	\$22.19
3	satin nickel/frosted	Zinc/Acrylic	44	33	133.50.107	\$21.04
4	gunmetal/frosted	Zinc/Acrylic	44	33	133.50.103	\$24.67
5	gunmetal/frosted	Zinc/Acrylic	35	30	133.50.102	\$19.37
6	gold champagne/frosted	Zinc/Acrylic	35	30	133.50.100	\$17.42
7	polished nickel/frosted	Zinc/Acrylic	35	30	133.50.104	\$19.37
8	satin nickel/frosted	Zinc/Acrylic	35	30	133.50.106	\$16.59

Note
Supplied with 1" mounting screws.

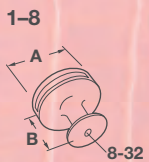

URBAN/INDUSTRIAL

Raw. Real. Rebar. Industrial design takes the wabi-sabi approach; it's the rough edges that make things interesting. Industrial brings us smoldering greys and blacks, glass, concrete, bent steel, chapped brick and high ceilings. Metal is a mainstay. Deco adds to the true grit with a welded edge, a "used" look or knurly textures.







Urban NEW

BY HÄFELE

	Finish	Material	A	C	Item No.	SRP/pc.
1	bronze	Aluminum	181	160	106.70.212	\$9.59
2	dark pewter	Aluminum	181	160	106.70.090	\$9.59
3	matt gray	Aluminum	181	160	106.70.091	\$9.59
4	bronze	Aluminum	214	192	106.70.202	\$9.84
5	dark pewter	Aluminum	214	192	106.70.200	\$9.84
6	matt gray	Aluminum	214	192	106.70.201	\$9.84
7	graphite	Zinc	-	-	106.70.185	\$5.29
8	bronze	Zinc	-	-	106.70.186	\$5.29

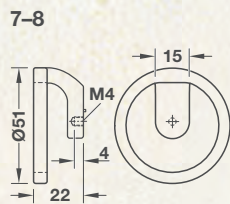
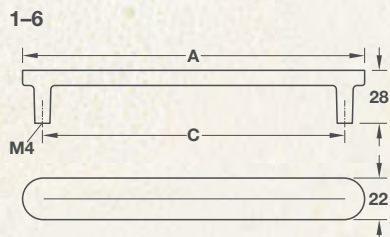

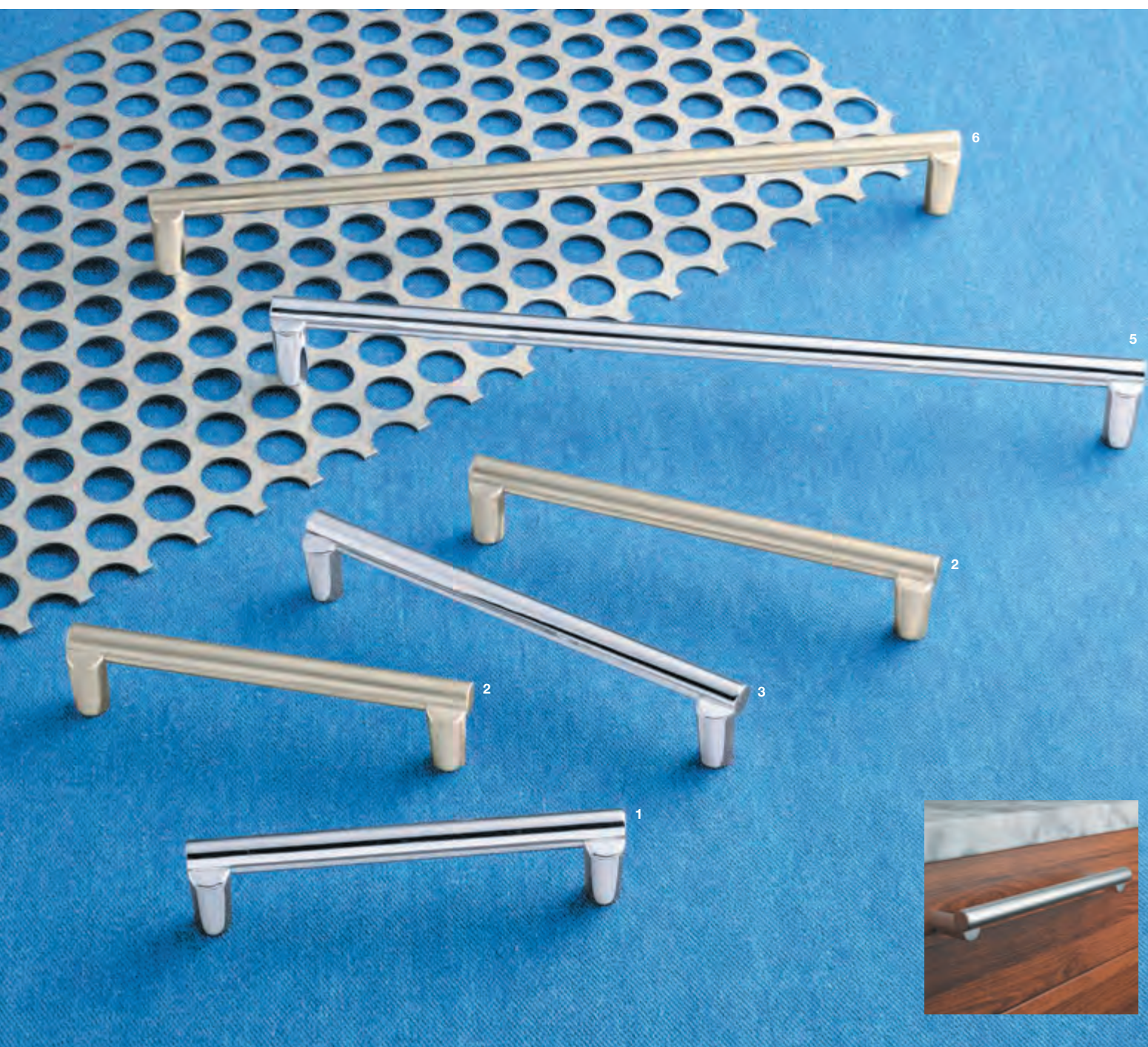

Urban **NEW**

BY HÄFELE

	Finish	Material	A	B	C	Item No.	SRP/pc.
1	polished chrome	Zinc	143	32	128	106.69.162	\$10.67
2	brushed nickel	Zinc	143	32	128	106.69.110	\$11.36
3	polished chrome	Zinc	174	32	160	106.69.022	\$12.15
4	brushed nickel	Zinc	174	32	160	106.69.020	\$12.66
5	polished chrome	Zinc	334	35	320	106.69.163	\$23.30
6	brushed nickel	Zinc	334	35	320	106.69.111	\$25.38

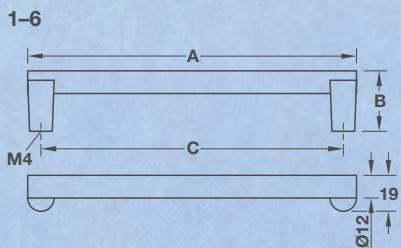

Dimensions in mm unless otherwise noted. Prices subject to change.

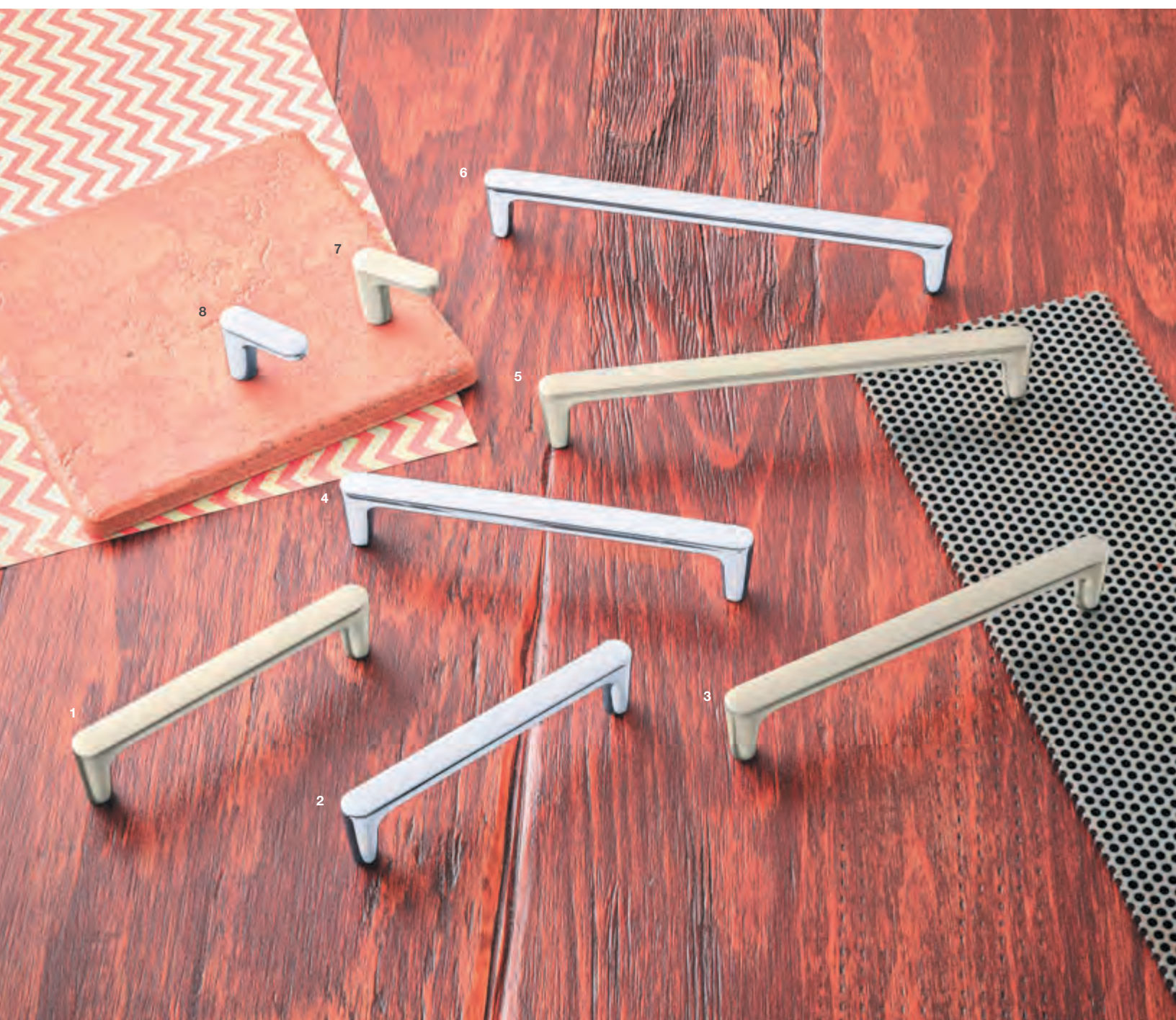

Urban NEW

BY HÄFELE

	Finish	Material	A	C	Item No.	SRP/pc.
1	brushed nickel	Zinc	108	96	106.69.120	\$5.57
2	polished chrome	Zinc	108	96	106.69.140	\$5.49
3	brushed nickel	Zinc	140	128	106.69.121	\$6.88
4	polished chrome	Zinc	140	128	106.69.141	\$6.71
5	brushed nickel	Zinc	171	160	106.69.030	\$8.03
6	polished chrome	Zinc	171	160	106.69.032	\$7.83
7	brushed nickel	Zinc	-	-	106.69.150	\$2.65
8	polished chrome	Zinc	-	-	106.69.152	\$2.56

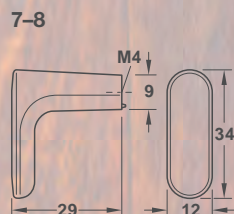
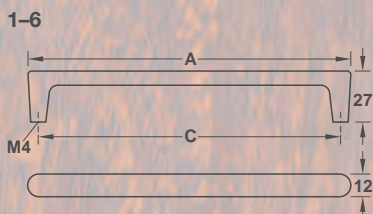



Textile/Bent

BY HÄFELE

- | | Finish |
|---|------------------------|
| 1 | matt black |
| 2 | champagne colored matt |
| 3 | polished brass |
| 4 | brushed nickel |
| 5 | matt black |

- | | Material | Item No. | SRP/pc. |
|---|-----------------|-----------------|----------------|
| 1 | Zinc | 106.70.003 | \$13.63 |
| 2 | Zinc | 106.70.000 | \$13.63 |
| 3 | Zinc | 106.70.005 | \$18.91 |
| 4 | Zinc | 106.70.013 | \$15.17 |
| 5 | Zinc | 106.70.011 | \$12.69 |

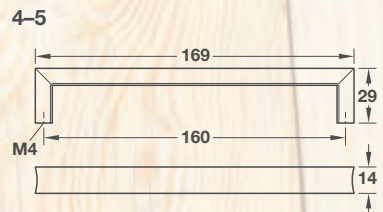
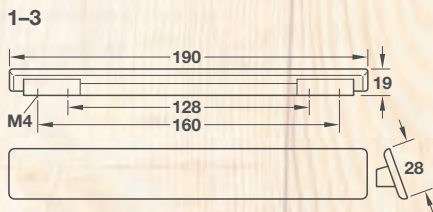

Dimensions in mm unless otherwise noted. Prices subject to change.



Urban

BY HÄFELE - 4-7

	Finish	Material	Item No.	SRP/pc.
1	matt nickel	Zinc	101.80.603	\$16.15
2	brushed nickel	Brass	106.34.643	\$43.82
3	matt nickel	Zinc	116.22.610	\$5.35
4	polished chrome	Zinc	110.34.271	\$9.31
5	polished chrome	Zinc	110.34.274	\$15.84
6	brushed nickel	Zinc	110.34.674	\$15.84
7	brushed nickel	Zinc	110.34.671	\$9.31
8	stainless steel	Zinc	152.16.001	\$108.22

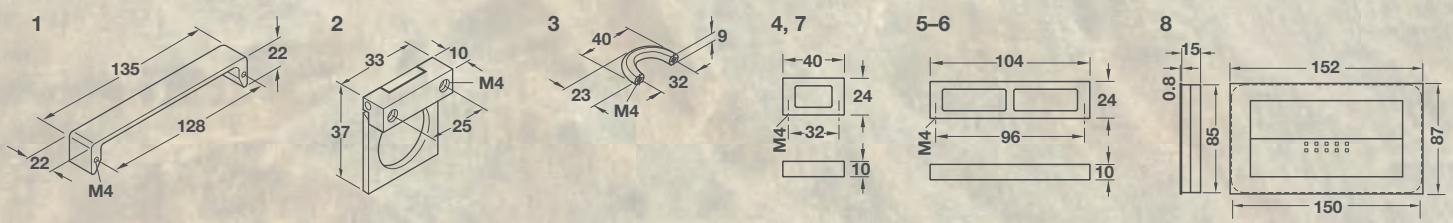

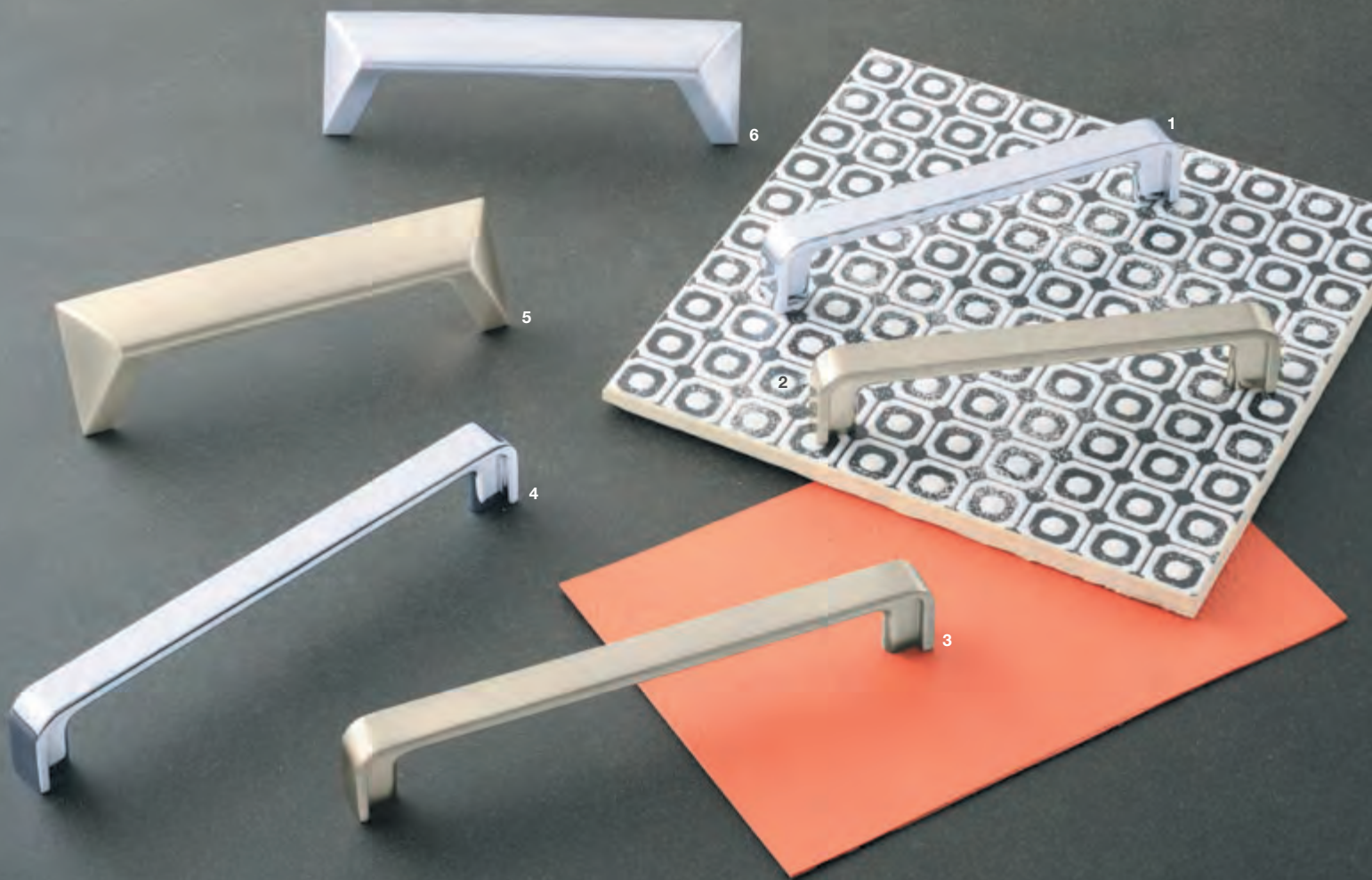

Urban

BY HÄFELE - 1-4

	Finish	Material	A	C	Item No.	SRP/pc.
1	polished chrome	Zinc	146	128	110.34.265	\$10.92
2	brushed nickel	Zinc	146	128	110.34.665	\$9.60
3	brushed nickel	Zinc	178	160	110.34.666	\$11.53
4	polished chrome	Zinc	178	160	110.34.266	\$9.61
5	matt nickel	Zinc	-	-	151.54.600	\$16.44
6	matt chrome	Zinc	-	-	151.54.400	\$16.44

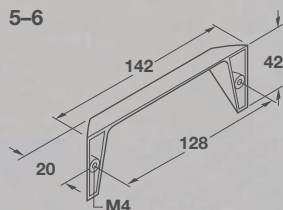
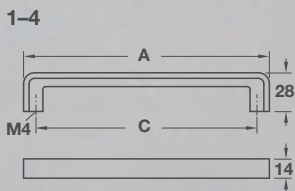



Urban

	Finish	Material	Item No.	SRP/pc.
1	highlighted bronze	Brass	108.57.111	\$60.74
2	stainless steel	Zinc	111.59.002	\$29.02
3	matt black	Zinc	116.22.316	\$4.84
4	matt black	Brass	151.04.319	\$98.32

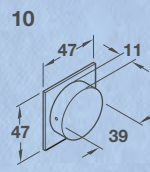
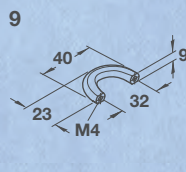
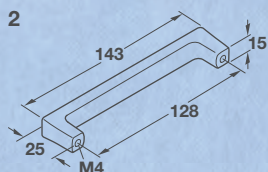
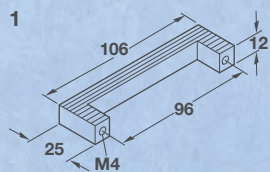



Urban

	Finish	Material	Item No.	SRP/pc.
1	silver matt	Zinc	106.65.650	\$11.87
2	matt black	Zinc	106.65.350	\$8.90
3	silver matt	Zinc	106.65.646	\$22.36
4	matt black	Zinc	106.65.346	\$17.86
5	polished black	Zinc	105.43.300	\$9.42
6	stainless steel look	Zinc	105.43.400	\$19.14

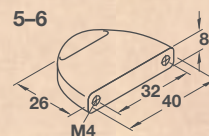
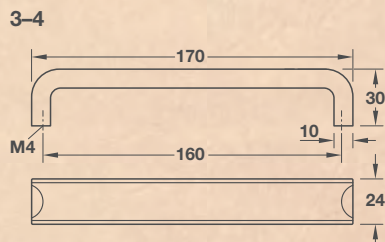
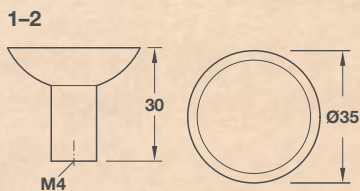

Dimensions in mm unless otherwise noted. Prices subject to change.



District



	Finish	Material	A	C	Item No.	SRP/pc.
1	oil-rubbed bronze	Zinc	-	-	155.01.782	\$5.48
2	polished chrome	Zinc	-	-	155.01.784	\$5.28
3	oil-rubbed bronze	Zinc	143	128	155.01.902	\$18.71
4	polished chrome	Zinc	143	128	155.01.904	\$17.85
5	oil-rubbed bronze	Zinc	207	192	155.01.922	\$26.64
6	polished chrome	Zinc	207	192	155.01.924	\$25.18
7	oil-rubbed bronze	Zinc	175	160	155.01.912	\$22.10
8	polished chrome	Zinc	175	160	155.01.914	\$21.10

1-2

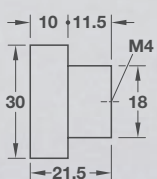

3-8

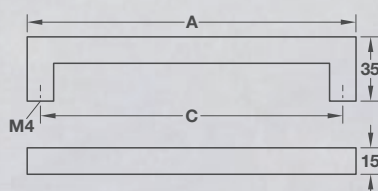



District



	Finish	Material	A	C	Item No.	SRP/pc.
1	brushed brass	Zinc	143	128	155.01.905	\$18.61
2	brushed brass	Zinc	175	160	155.01.915	\$21.98
3	brushed brass	Zinc	207	192	155.01.925	\$26.28
4	brushed brass	Zinc	-	-	155.01.785	\$5.57
5	antique silver	Zinc	143	128	155.01.903	\$18.61
6	antique silver	Zinc	175	160	155.01.913	\$21.98
7	antique silver	Zinc	207	192	155.01.923	\$26.44
8	antique silver	Zinc	-	-	155.01.783	\$5.38

1-3, 5-7

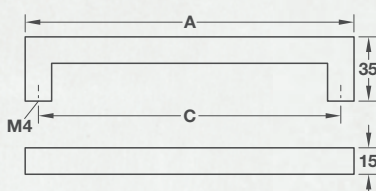

4, 8

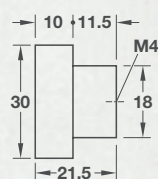



Urban



	Finish	Material	A	C	Item No.	SRP/pc.
1	brushed brass	Aluminum	-	-	132.19.210	\$8.81
2	matt black	Aluminum	-	-	132.19.211	\$5.27
3	polished chrome	Aluminum	-	-	132.15.230	\$5.30
4	stainless steel look	Aluminum	-	-	132.15.630	\$5.31
5	iron colored	Zinc	247	224	116.60.201	\$17.51
6	iron colored	Zinc	183	160	116.60.200	\$13.53

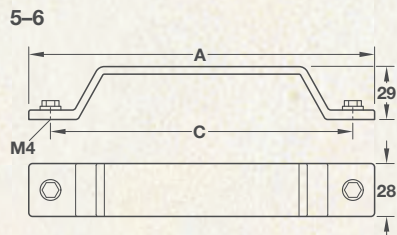
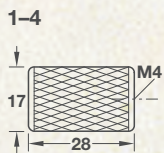



Essex* and Urban



	Finish	Material	A	C	Item No.	SRP/pc.
1	stainless steel look	Zinc	-	-	124.40.053	\$25.32
*2	polished chrome	Zinc	163	128	155.01.880	\$18.81
*3	brushed nickel	Zinc	163	128	155.01.890	\$14.16
*4	polished chrome	Zinc	227	192	155.01.881	\$22.24
*5	brushed nickel	Zinc	227	192	155.01.891	\$16.25
6	stainless steel	Zinc	-	-	113.97.046	\$19.07
7	polished chrome	Zinc	-	-	113.97.246	\$18.30
8	stainless steel	Zinc	-	-	113.97.071	\$13.78
9	polished chrome	Zinc	-	-	113.97.272	\$12.46

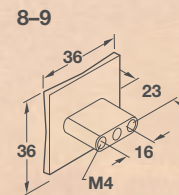
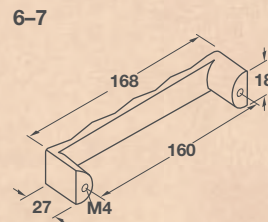
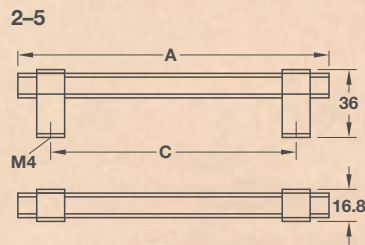
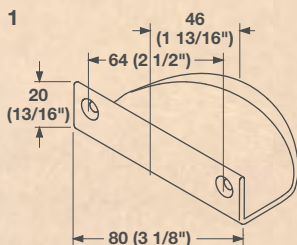



Calypso

	Finish	Material	A	C	Item No.	SRP/pc.
1	oil-rubbed bronze	Zinc	107	96	113.97.424	\$16.49
2	polished chrome	Zinc	107	96	113.97.224	\$17.81
3	stainless steel	Zinc	107	96	113.97.024	\$18.37
4	oil-rubbed bronze	Zinc	203	192	113.97.427	\$21.92
5	polished chrome	Zinc	203	192	113.97.227	\$23.44
6	stainless steel	Zinc	203	192	113.97.027	\$23.98
7	oil-rubbed bronze	Zinc	-	-	113.97.410	\$18.93
8	polished chrome	Zinc	-	-	113.97.210	\$19.95
9	stainless steel	Zinc	-	-	113.97.010	\$19.26

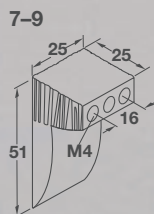
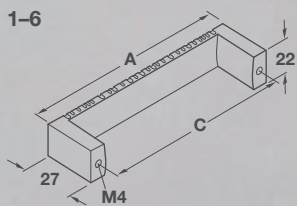

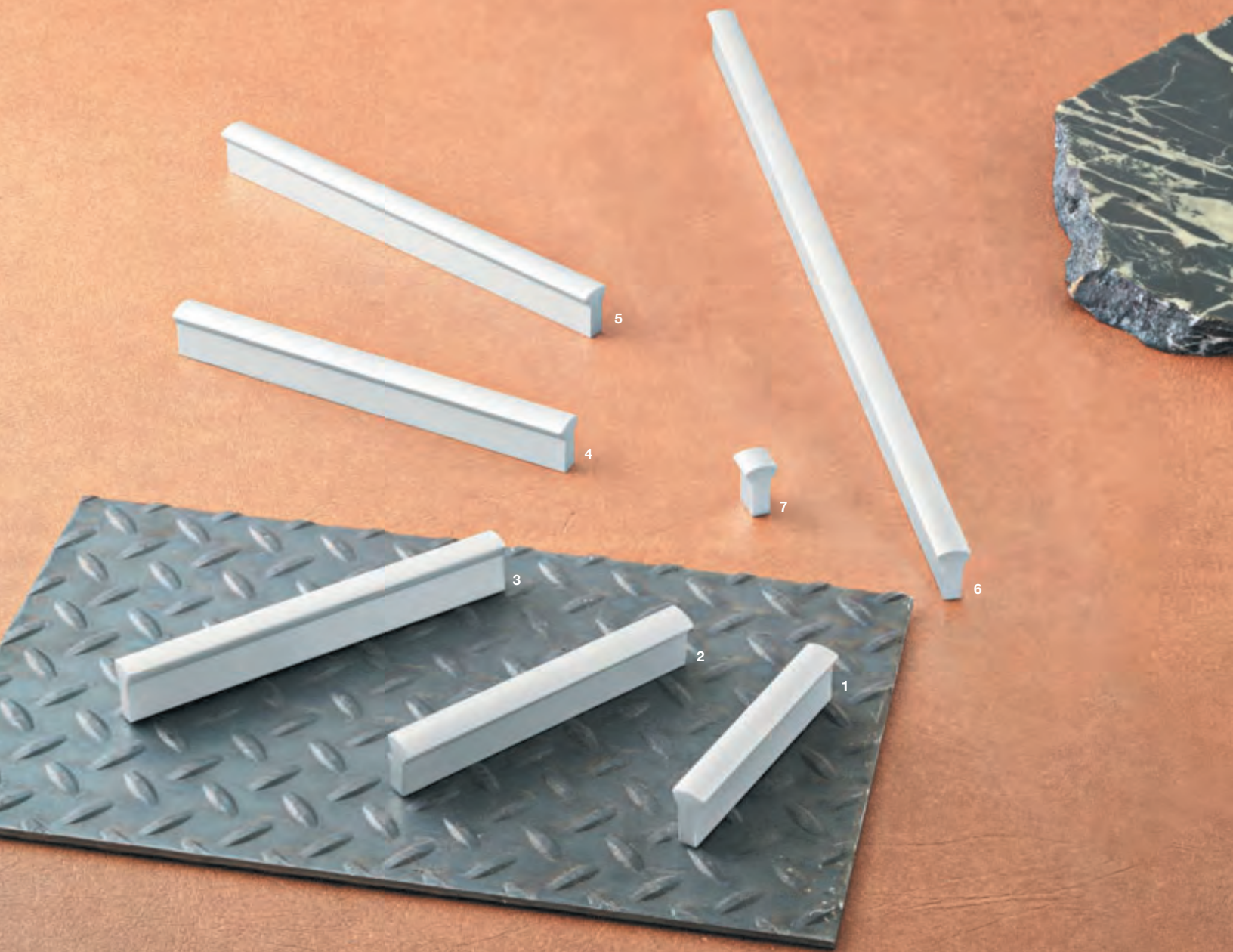

Metropolitan

	Finish	Material	A	C	Item No.	SRP/pc.
1	matt	Aluminum	104	64	103.89.901	\$20.84
2	matt	Aluminum	136	96	103.89.902	\$25.16
3	matt	Aluminum	168	128	103.89.903	\$28.02
4	matt	Aluminum	200	160	103.89.904	\$30.88
5	matt	Aluminum	232	192	103.89.905	\$33.06
6	matt	Aluminum	488	448	103.89.913	\$68.20
7	matt	Aluminum	-	-	135.08.900	\$10.56

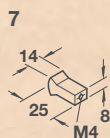
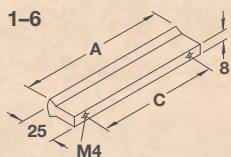



Roxbury NEW

	Finish	Material	A	C	Item No.	SRP/pc.
1	matt gold	Aluminum/Zinc	80	64	106.04.020	\$17.28
2	matt gold	Aluminum/Zinc	272	256	106.04.050	\$32.14
3	dark bronze	Aluminum/Zinc	272	256	106.04.052	\$32.14
4	dark bronze	Aluminum/Zinc	80	64	106.04.022	\$17.28
5	matt black	Aluminum/Zinc	272	256	106.04.051	\$32.14
6	matt black	Aluminum/Zinc	80	64	106.04.021	\$17.28

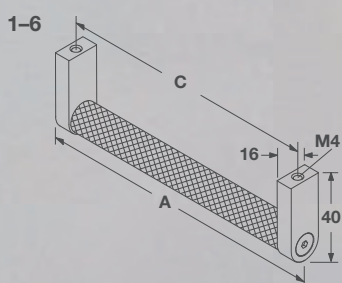



Roxbury NEW

	Finish	Material	A	C	Item No.	SRP/pc.
1	matt gold	Aluminum/Zinc	144	128	106.04.030	\$22.22
2	matt gold	Aluminum/Zinc	176	160	106.04.040	\$27.19
3	dark bronze	Aluminum/Zinc	176	160	106.04.042	\$27.19
4	dark bronze	Aluminum/Zinc	144	128	106.04.032	\$22.22
5	matt black	Aluminum/Zinc	176	160	106.04.041	\$27.19
6	matt black	Aluminum/Zinc	144	128	106.04.031	\$22.22

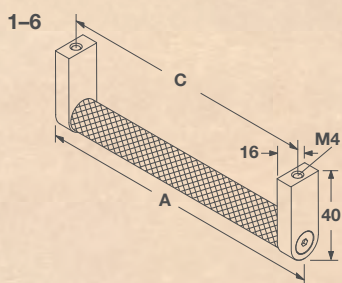

Dimensions in mm unless otherwise noted. Prices subject to change.



Esquire

BY AMEROCK

	Finish	Material	A	C	Item No.	SRP/pc.
1	polished nickel/stainless steel	Zinc/Stainless Steel	119	76 (3")/96	133.50.696	\$23.06
2	polished nickel/stainless steel	Zinc/Stainless Steel	343	320	133.50.695	\$47.93
3	polished nickel/black bronzed	Zinc/Stainless Steel	343	320	133.50.685	\$47.93
4	polished nickel/black bronzed	Zinc/Stainless Steel	279	256	133.50.684	\$39.10
5	polished nickel/black bronzed	Zinc/Stainless Steel	119	76 (3")/96	133.50.686	\$23.06
6	polished nickel/black bronzed	Zinc/Stainless Steel	151	128	133.50.682	\$24.86
7	polished nickel/black bronzed	Zinc/Stainless Steel	183	160	133.50.683	\$26.62
8	polished nickel/black bronzed	Zinc/Stainless Steel	-	-	133.50.707	\$21.28

Note
Supplied with 1" mounting screws.

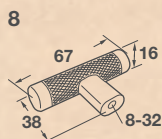
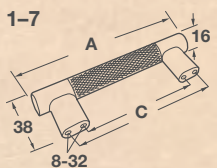



Esquire

BY AMEROCK

	Finish	Material	A	C	Item No.	SRP/pc.
1	polished nickel/stainless steel	Zinc/Stainless Steel	–	–	133.50.709	\$21.28
2	polished nickel/gunmetal	Zinc/Stainless Steel	–	–	133.50.708	\$21.28
3	polished nickel/gunmetal	Zinc/Stainless Steel	119	76 (3")/96	133.50.691	\$23.06
4	polished nickel/gunmetal	Zinc/Stainless Steel	151	128	133.50.687	\$24.86
5	polished nickel/gunmetal	Zinc/Stainless Steel	183	160	133.50.688	\$26.62
6	polished nickel/gunmetal	Zinc/Stainless Steel	279	256	133.50.689	\$39.10
7	polished nickel/gunmetal	Zinc/Stainless Steel	343	320	133.50.690	\$47.63
8	polished nickel/stainless steel	Zinc/Stainless Steel	279	256	133.50.694	\$39.10

Note
Supplied with 1" mounting screws.

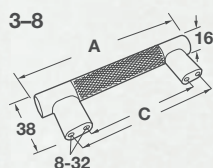
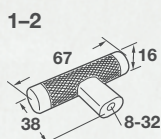

Dimensions in mm unless otherwise noted. Prices subject to change.

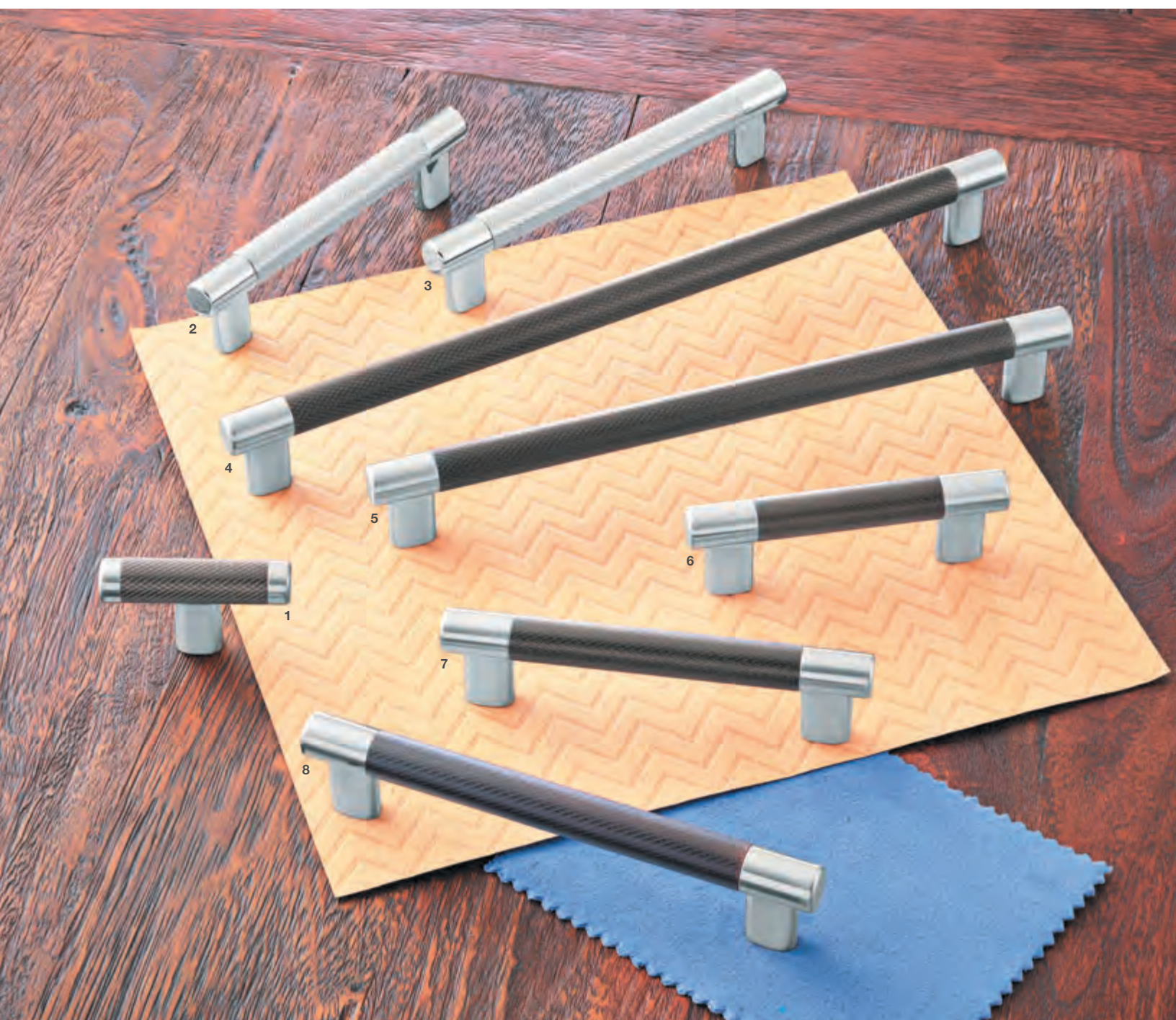

Esquire

BY AMEROCK

	Finish	Material	A	C	Item No.	SRP/pc.
1	satin nickel/oil-rubbed bronze	Zinc/Stainless Steel	–	–	133.50.710	\$21.28
2	polished nickel/stainless steel	Zinc/Stainless Steel	151	128	133.50.692	\$24.86
3	polished nickel/stainless steel	Zinc/Stainless Steel	183	160	133.50.693	\$26.62
4	satin nickel/oil-rubbed bronze	Zinc/Stainless Steel	343	320	133.50.701	\$47.93
5	satin nickel/oil-rubbed bronze	Zinc/Stainless Steel	279	256	133.50.700	\$39.10
6	satin nickel/oil-rubbed bronze	Zinc/Stainless Steel	119	76 (3")/96	133.50.702	\$23.06
7	satin nickel/oil-rubbed bronze	Zinc/Stainless Steel	151	128	133.50.697	\$24.86
8	satin nickel/oil-rubbed bronze	Zinc/Stainless Steel	183	160	133.50.698	\$26.62

Note
Supplied with 1" mounting screws.

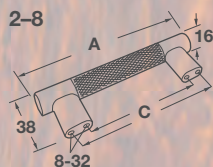
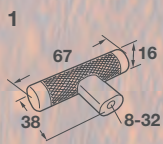



Rochdale/ Kontur

BY AMEROCK

ADA 3-5

	Finish	Material	A	B	C	Item No.	SRP/pc.
1	satin nickel	Zinc	-	-	-	133.50.142	\$12.32
2	satin nickel	Zinc	-	-	-	133.50.632	\$7.29
3	satin nickel	Zinc	121	30	96	133.50.372	\$9.50
4	satin nickel	Zinc	154	32	128	133.50.370	\$11.08
5	satin nickel	Zinc	186	33	160	133.50.371	\$12.66
6	stainless steel	Zinc	-	-	-	133.50.705	\$12.42

Note

Supplied with 1" mounting screws.

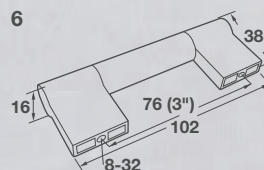
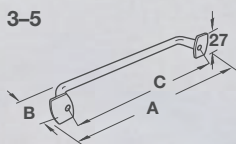
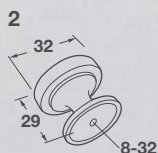
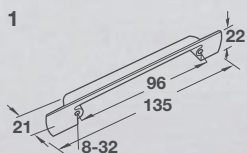

ART DECO/GLAM

Old Hollywood panache with notes of bling. Glam style spotlights bright golds and rich velvets in regal jewel tones that contrast with lavish light catchers. Deco pulls are paved with pavé crystals, knobs add a mod accent with glossy chrome while handles radiate the lush warmth of polished gold.





Art Deco/ Glam

BY HÄFELE

NEW

	Finish	Material	A	B	C	D	Item No.	SRP/pc.
1	matt black/marble	Zinc	-	-	-	-	106.70.180	\$6.49
2	matt black/marble	Zinc	-	-	-	-	106.70.175	\$12.79
3*	brushed nickel	Zinc	130	32	96	15	106.70.150	\$8.77
4*	brushed nickel	Zinc	161	32	128	18	106.70.151	\$10.77
5*	brushed nickel	Zinc	236	35	192	20	106.70.152	\$14.91
6*	brushed nickel	Zinc	-	-	-	-	106.70.171	\$6.74

Note
*Refer to page 255 for matching appliance pulls.

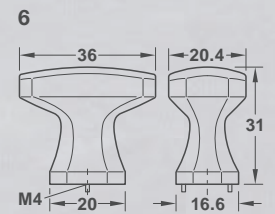
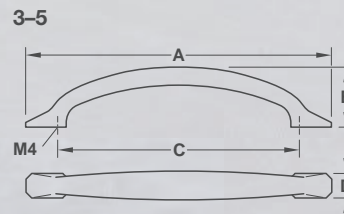
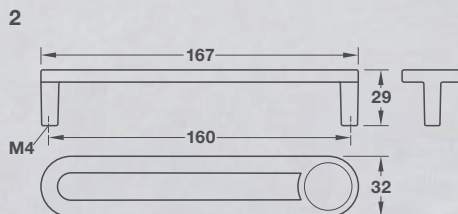
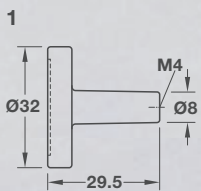



Art Deco/ Glam

BY HÄFELE

NEW

	Finish	Material	A	B	C	D	Item No.	SRP/pc.
1	matt gold	Zinc	130	32	96	15	106.70.160	\$10.35
2	matt gold	Zinc	161	32	128	18	106.70.161	\$11.81
3	matt gold	Zinc	236	35	192	20	106.70.162	\$17.82
4	oil-rubbed bronze	Zinc	130	32	96	15	106.70.220	\$9.44
5	oil-rubbed bronze	Zinc	161	32	128	18	106.70.221	\$11.58
6	oil-rubbed bronze	Zinc	236	35	192	20	106.70.222	\$16.00
7	oil-rubbed bronze	Zinc	-	-	-	-	106.70.173	\$7.30
8	matt gold	Zinc	-	-	-	-	106.70.172	\$7.40

Note
Refer to page 255 for matching appliance pulls.

1-6

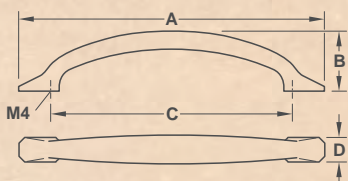

7-8

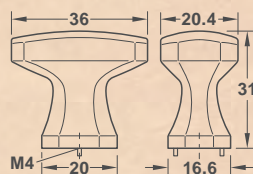

Dimensions in mm unless otherwise noted. Prices subject to change.



Paragon

BY HÄFELE

	Finish	Material	A	B	C	D	Item No.	SRP/pc.
1	oil-rubbed bronze	Zinc	-	-	-	-	102.64.100	\$18.38
2	polished nickel	Zinc	-	-	-	-	102.64.700	\$17.25
3	satin nickel	Zinc	-	-	-	-	102.64.600	\$18.03
4	satin nickel	Zinc	115	33	96	17	123.08.441	\$22.84
5	satin nickel	Zinc	147	33	128	17	123.08.442	\$26.28
6	satin nickel	Zinc	224	36	8"	19	123.08.443	\$37.48
7	oil-rubbed bronze	Zinc	115	33	96	17	123.08.141	\$24.96
8	oil-rubbed bronze	Zinc	147	33	128	17	123.08.142	\$27.26
9	oil-rubbed bronze	Zinc	224	36	8"	19	123.08.143	\$46.82
10	polished nickel	Zinc	224	36	8"	19	123.08.748	\$33.64
11	polished nickel	Zinc	147	33	128	17	123.08.747	\$23.02
12	polished nickel	Zinc	115	33	96	17	123.08.746	\$18.05

Note

Refer to page 256 for matching appliance pulls.

1-3

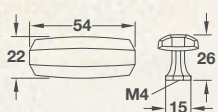

4-12

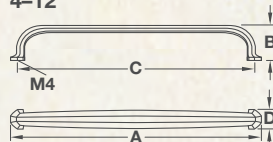



Art Deco/Glam

BY HÄFELE - 1-4

	Finish	Material	A	C	Item No.	SRP/pc.
1	polished chrome	Zinc	180	160	110.34.286	\$12.24
2	polished chrome	Zinc	212	192	110.34.287	\$11.75
3	brushed nickel	Zinc	212	192	110.34.687	\$11.71
4	brushed nickel	Zinc	180	160	110.34.686	\$12.28
5	polished chrome/polished gold	Brass	-	-	117.44.200	\$17.40

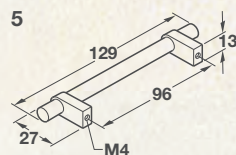
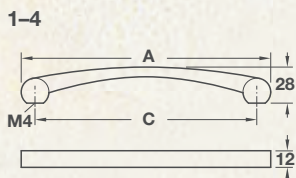

Dimensions in mm unless otherwise noted. Prices subject to change.



Zelda



	Finish	Material	A	B	C	D	Item No.	SRP/pc.
1	antique silver	Zinc	-	-	-	-	155.02.084	\$9.34
2	antique silver	Zinc	109	33	96	13	155.02.041	\$8.25
3	antique silver	Zinc	144	35	128	15	155.02.051	\$9.99
4	antique silver	Zinc	176	37	160	15	155.02.061	\$12.06
5	antique silver	Zinc	212	40	192	17	155.02.071	\$15.05
6	oil-rubbed bronze	Zinc	-	-	-	-	155.02.080	\$9.34
7	oil-rubbed bronze	Zinc	109	33	96	13	155.02.042	\$8.59
8	oil-rubbed bronze	Zinc	144	35	128	15	155.02.052	\$10.73
9	oil-rubbed bronze	Zinc	176	37	160	15	155.02.062	\$12.93
10	oil-rubbed bronze	Zinc	212	40	192	17	155.02.072	\$13.34

1, 6

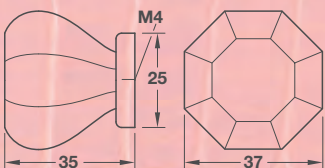

2-5, 7-10

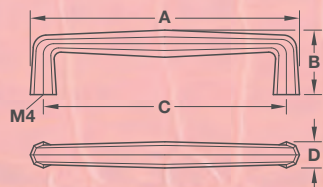



Zelda



	Finish	Material	A	B	C	D	Item No.	SRP/pc.
1	brushed brass	Zinc	-	-	-	-	155.02.081	\$9.34
2	brushed brass	Zinc	109	33	96	13	155.02.043	\$8.66
3	brushed brass	Zinc	144	35	128	15	155.02.053	\$10.43
4	brushed brass	Zinc	176	37	160	15	155.02.063	\$12.60
5	brushed brass	Zinc	212	40	192	17	155.02.073	\$16.01
6	polished nickel	Zinc	212	40	192	17	155.02.070	\$15.41
7	polished nickel	Zinc	176	37	160	15	155.02.060	\$12.20
8	polished nickel	Zinc	144	35	128	15	155.02.050	\$10.01
9	polished nickel	Zinc	109	33	96	13	155.02.040	\$8.18
10	polished nickel	Zinc	-	-	-	-	155.02.083	\$9.27

1, 10

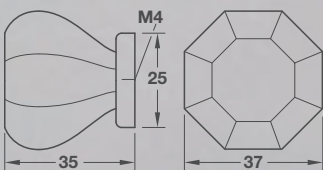

2-5, 6-9

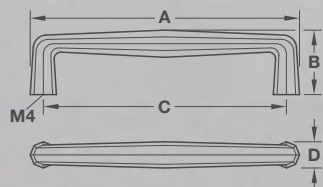

Dimensions in mm unless otherwise noted. Prices subject to change.



Art Deco/ Glam



	Finish	Material	A	B	C	Item No.	SRP/pc.
1	polished chrome, crystal elements	Zinc	-	-	-	111.25.262	\$135.22
2	polished chrome, crystal elements	Zinc	-	-	-	111.25.252	\$48.44
3	polished nickel, crystal elements	Zinc	-	-	-	132.19.710	\$53.96
4	polished nickel, crystal elements	Zinc	173	25	128	103.29.712	\$152.28
5	polished nickel, crystal elements	Zinc	136	21	96	103.29.711	\$115.58

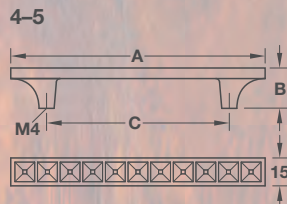
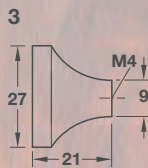
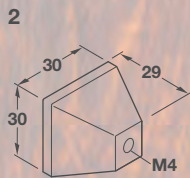
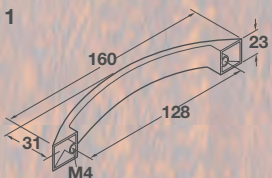



Crystalline* and Art Deco/Glam

- Finish**
- *1 clear/matt
 - *2 frosted/matt
 - *3 clear/matt
 - *4 frosted/matt
 - 5 polished/polished chrome
 - 6 polished/gold colored, polished

- Material**
- Glass/Stainless Steel
 - Glass/Stainless Steel
 - Glass/Stainless Steel
 - Glass/Stainless Steel
 - Crystal/Zinc
 - Crystal/Zinc

- Item No.** **SRP/pc.**
- 103.79.401 \$65.04
 - 103.79.411 \$71.84
 - 135.73.400 \$27.76
 - 135.73.410 \$30.64
 - 139.60.422 \$57.64
 - 138.72.800 \$47.20

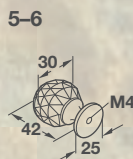
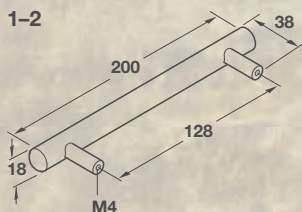

Dimensions in mm unless otherwise noted. Prices subject to change.



Carrione

BY AMEROCK

	Finish	Material	A	C	Item No.	SRP/pc.
1	marbleized white/polished nickel	Zinc	-	-	133.53.033	\$21.12
2	marbleized white/satin nickel	Zinc	-	-	133.53.104	\$25.34
3	marbleized white/black bronzed	Zinc	-	-	133.53.094	\$25.61
4	marbleized white/black bronzed	Zinc	160	96	133.53.095	\$48.07
5	marbleized white/polished nickel	Zinc	160	96	133.53.035	\$47.57
6	marbleized white/black bronzed	Zinc	191	128	133.53.096	\$56.06
7	marbleized white/satin nickel	Zinc	191	128	133.53.106	\$55.49
8	marbleized white/polished nickel	Zinc	191	128	133.53.036	\$55.49
9	marbleized white/black bronzed	Zinc	222	160	133.53.097	\$64.08
10	marbleized white/polished nickel	Zinc	222	160	133.53.103	\$63.46

Note
Supplied with 1" mounting screws.

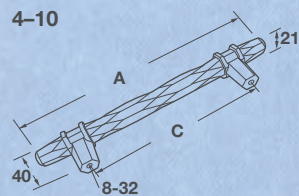
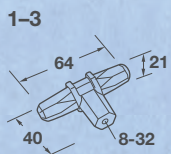



Carrione

BY AMEROCK

	Finish	Material	A	C	Item No.	SRP/pc.
1	marbleized white/oil-rubbed bronze	Zinc	160	96	133.53.037	\$47.57
2	marbleized white/gold champagne	Zinc	160	96	133.53.099	\$47.57
3	marbleized white/satin nickel	Zinc	160	96	133.53.105	\$47.57
4	marbleized white/oil-rubbed bronze	Zinc	222	160	133.53.102	\$63.46
5	marbleized white/gold champagne	Zinc	222	160	133.53.101	\$63.46
6	marbleized white/satin nickel	Zinc	222	160	133.53.107	\$63.46
7	marbleized white/gold champagne	Zinc	191	128	133.53.100	\$55.49
8	marbleized white/gold champagne	Zinc	-	-	133.53.098	\$25.34
9	marbleized white/oil-rubbed bronze	Zinc	191	128	133.53.038	\$55.49
10	marbleized white/oil-rubbed bronze	Zinc	-	-	133.53.034	\$21.12

Note
Supplied with 1" mounting screws.

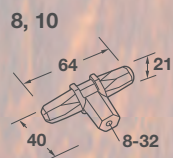
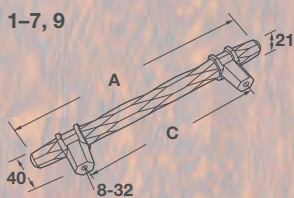

Dimensions in mm unless otherwise noted. Prices subject to change.

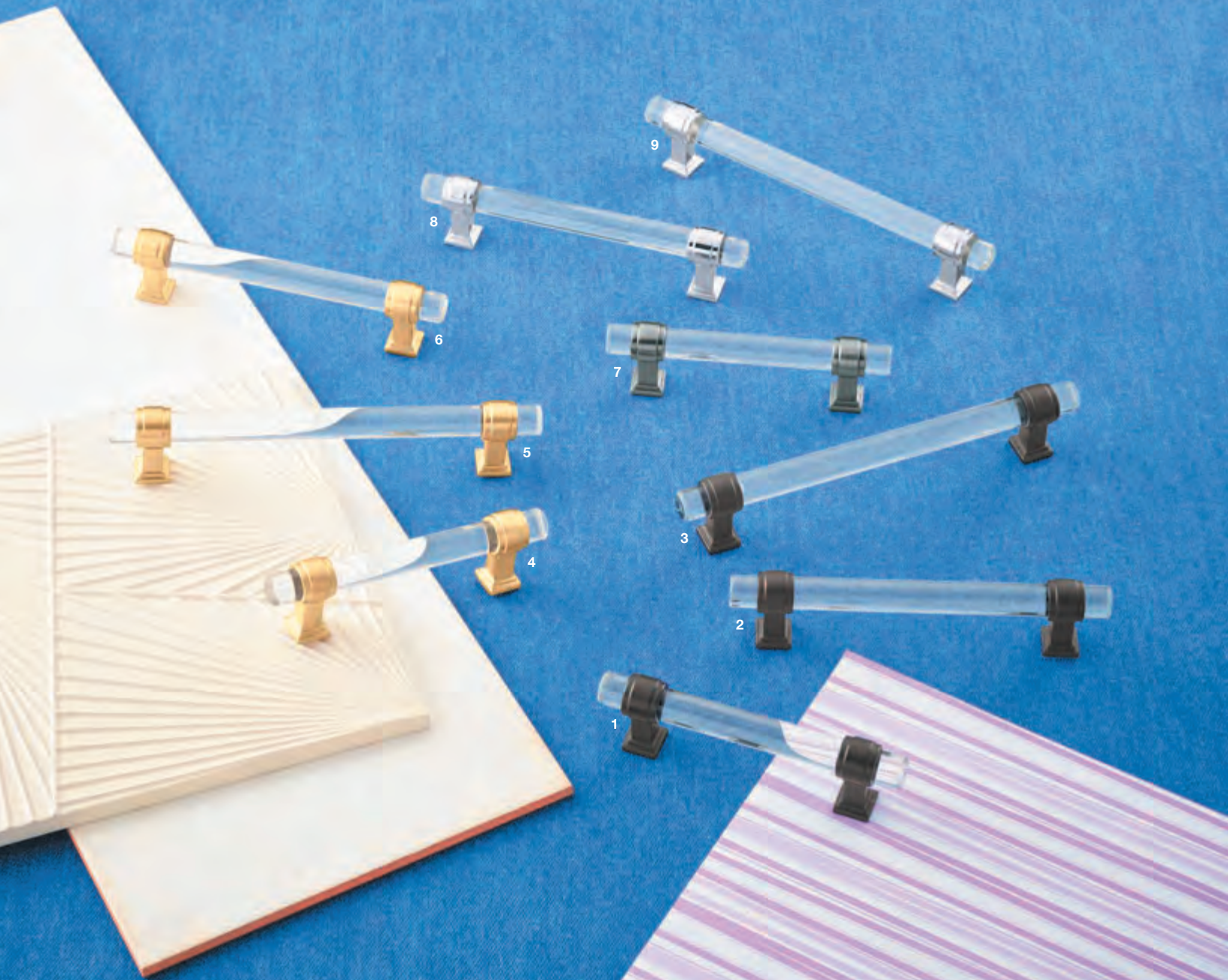

Glacio

BY AMEROCK

	Finish	Material	A	C	Item No.	SRP/pc.
1	black bronzed/clear	Zinc/Acrylic	135	96	133.53.127	\$44.35
2	black bronzed/clear	Zinc/Acrylic	167	128	133.53.128	\$53.23
3	black bronzed/clear	Zinc/Acrylic	200	160	133.53.129	\$68.98
4	gold champagne/clear	Zinc/Acrylic	135	96	133.53.130	\$44.35
5	gold champagne/clear	Zinc/Acrylic	200	160	133.53.132	\$68.98
6	gold champagne/clear	Zinc/Acrylic	167	128	133.53.131	\$53.23
7	gunmetal/clear	Zinc/Acrylic	135	96	133.53.133	\$44.35
8	polished nickel/clear	Zinc/Acrylic	167	128	133.53.039	\$53.23
9	polished nickel/clear	Zinc/Acrylic	200	160	133.53.040	\$68.95

Note
Supplied with 1" mounting screws.

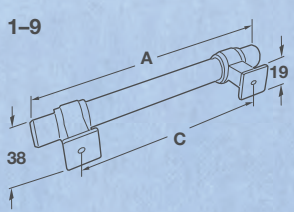



Glacio

BY AMEROCK

	Finish	Material	A	C	Item No.	SRP/pc.
1	satin nickel/clear	Zinc/Acrylic	135	96	133.53.140	\$44.35
2	satin nickel/clear	Zinc/Acrylic	167	128	133.53.141	\$53.23
3	satin nickel/clear	Zinc/Acrylic	200	160	133.53.142	\$68.98
4	polished nickel/clear	Zinc/Acrylic	135	96	133.53.139	\$44.35
5	gunmetal/clear	Zinc/Acrylic	167	128	133.53.134	\$53.23
6	gunmetal/clear	Zinc/Acrylic	200	160	133.53.135	\$68.98
7	oil-rubbed bronze/clear	Zinc/Acrylic	135	96	133.53.136	\$44.35
8	oil-rubbed bronze/clear	Zinc/Acrylic	167	128	133.53.137	\$53.23
9	oil-rubbed bronze/clear	Zinc/Acrylic	200	160	133.53.138	\$68.98

Note
Supplied with 1" mounting screws.

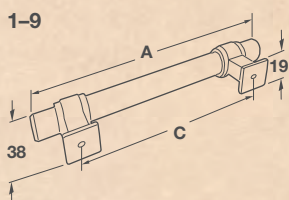

Dimensions in mm unless otherwise noted. Prices subject to change.



Glacio

BY AMEROCK

	Finish	Material	Item No.	SRP/pc.
1	gold champagne/clear	Aluminum/Synthetic Crystal	133.50.111	\$21.85
2	oil-rubbed bronze/clear	Aluminum/Synthetic Crystal	133.50.114	\$24.29
3	gunmetal/clear	Aluminum/Synthetic Crystal	133.50.117	\$21.85
4	gold champagne/clear	Aluminum/Synthetic Crystal	133.50.112	\$21.85
5	gunmetal/clear	Aluminum/Synthetic Crystal	133.50.115	\$24.29
6	oil-rubbed bronze/clear	Aluminum/Synthetic Crystal	133.50.118	\$21.85
7	gold champagne/clear	Aluminum/Synthetic Crystal	133.50.113	\$21.85
8	oil-rubbed bronze/clear	Aluminum/Synthetic Crystal	133.50.119	\$21.85
9	gunmetal/clear	Aluminum/Synthetic Crystal	133.50.116	\$24.29

Note
Supplied with 1" mounting screws.

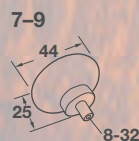
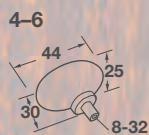
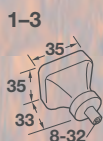



Abernathy and Glacio

BY AMEROCK

Finish

- 1 oil-rubbed bronze
- 2 antique silver
- 3 satin nickel
- 4 satin nickel/clear
- 5 polished nickel/clear
- 6 black bronzed/clear
- 7 satin nickel/clear
- 8 black bronzed/clear
- 9 polished nickel/clear
- 10 polished nickel/clear
- 11 satin nickel/clear
- 12 black bronzed/clear

Material

- Zinc/Acrylic
- Zinc/Acrylic
- Zinc/Acrylic
- Aluminum/Synthetic Crystal
- Aluminum/Synthetic Crystal
- Aluminum/Synthetic Crystal
- Aluminum/Synthetic Crystal
- Aluminum/Synthetic Crystal
- Aluminum/Synthetic Crystal
- Aluminum/Synthetic Crystal
- Aluminum/Synthetic Crystal
- Aluminum/Synthetic Crystal

Item No.

- 133.50.109 \$17.59
- 133.50.108 \$17.59
- 133.50.110 \$17.59
- 133.50.123 \$21.85
- 133.50.120 \$21.85
- 133.53.126 \$21.65
- 133.50.125 \$21.85
- 133.53.125 \$21.65
- 133.50.122 \$21.85
- 133.50.121 \$21.85
- 133.50.124 \$21.85
- 133.53.124 \$21.65

Note

Supplied with 1" mounting screws.

1-3

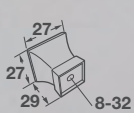

4-6

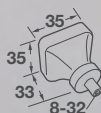

7-9



10-12

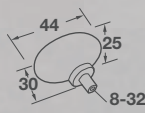

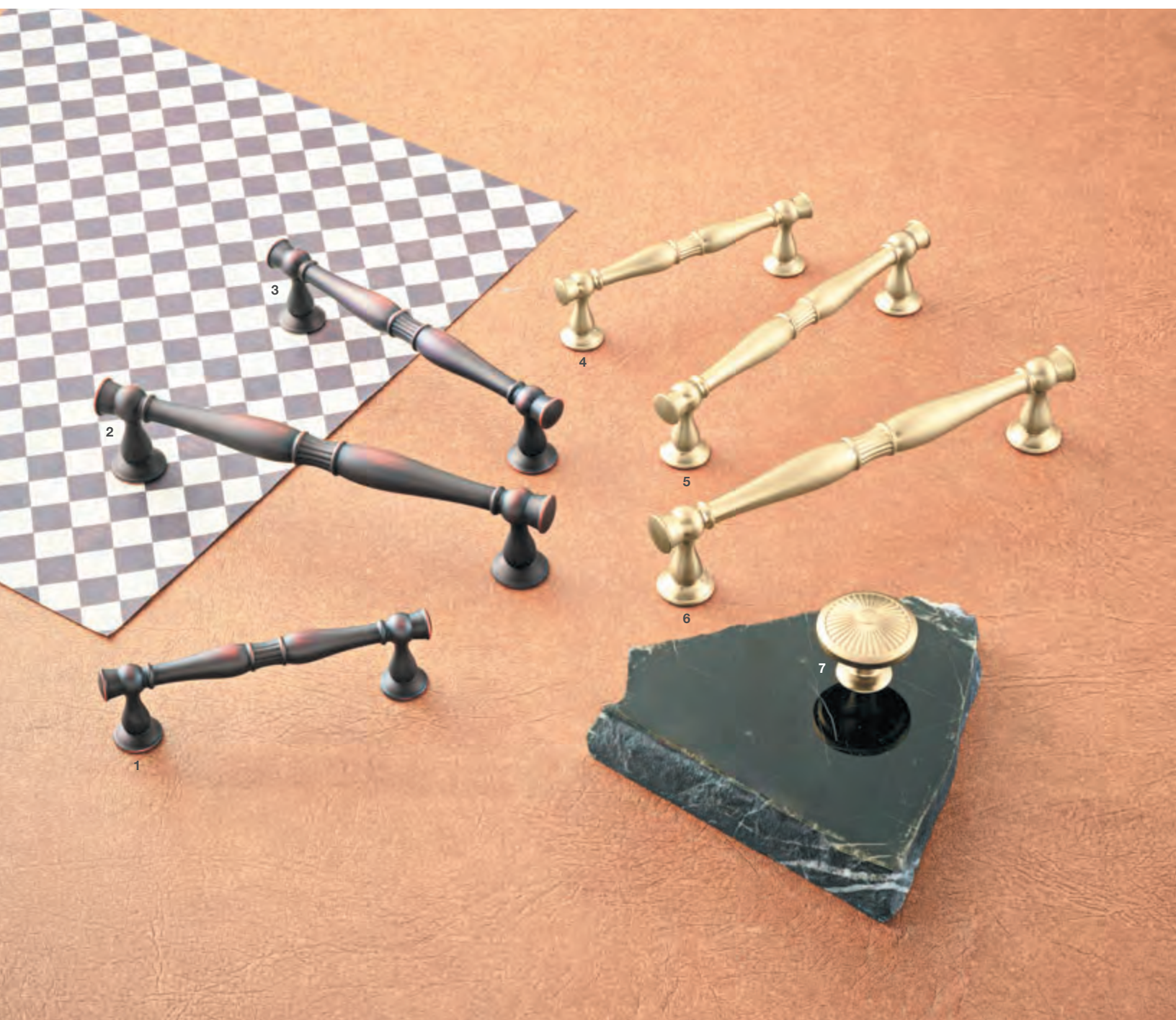

Crawford

BY AMEROCK

	Finish	Material	A	B	C	D	Item No.	SRP/pc.
1	oil-rubbed bronze	Zinc	119	35	96	19	133.50.258	\$15.71
2	oil-rubbed bronze	Zinc	187	41	160	22	133.50.257	\$19.59
3	oil-rubbed bronze	Zinc	154	37	128	21	133.50.256	\$24.67
4	gold champagne	Zinc	119	35	96	19	133.50.255	\$21.11
5	gold champagne	Zinc	154	37	128	21	133.50.253	\$21.04
6	gold champagne	Zinc	187	41	160	22	133.50.254	\$26.42
7	gold champagne	Zinc	35	-	-	30	133.50.303	\$17.59

Note
Supplied with 1" mounting screws.

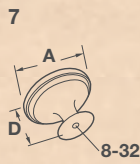
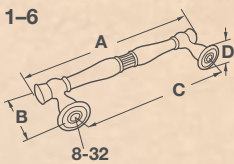



Crawford

BY AMEROCK

	Finish	Material	A	B	C	D	Item No.	SRP/pc.
1	satin nickel	Zinc	154	37	128	21	133.50.259	\$24.67
2	satin nickel	Zinc	119	35	96	19	133.50.261	\$15.71
3	satin nickel	Zinc	187	41	160	22	133.50.260	\$19.44
4	satin nickel	Zinc	-	-	-	-	133.50.307	\$13.17
5	oil-rubbed bronze	Zinc	-	-	-	-	133.50.305	\$13.17

Note
Supplied with 1" mounting screws.

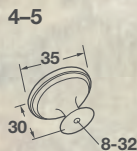
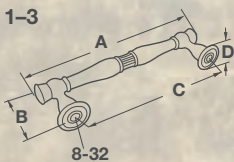



Carolynne

BY AMEROCK

	Finish	Material	A	B	C	Item No.	SRP/pc.
1	satin nickel	Zinc	173	32	128	133.50.203	\$18.29
2	satin nickel	Zinc	141	27	96	133.50.204	\$19.20
3	polished nickel	Zinc	173	32	128	133.50.201	\$20.17
4	satin nickel	Zinc	-	-	-	133.50.250	\$15.20

Note

Supplied with 1" mounting screws.

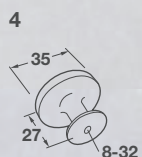
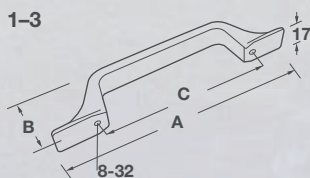



Mulholland

BY AMEROCK

ADA 4-9

	Finish	Material	A	B	C	D	Item No.	SRP/pc.
1	gold champagne	Zinc	32	-	-	21	133.53.182	\$10.64
2	gold champagne	Zinc	38	-	-	21	133.53.188	\$21.68
3	gold champagne	Zinc	95	27	76 (3")	17	133.53.183	\$12.42
4	gold champagne	Zinc	116	29	96	21	133.53.184	\$14.20
5	gold champagne	Zinc	149	32	128	22	133.53.185	\$15.94
6	gold champagne	Zinc	181	37	160	22	133.53.186	\$19.70
7	polished nickel	Zinc	181	37	160	22	133.53.193	\$17.59
8	polished nickel	Zinc	149	32	128	22	133.53.192	\$15.94
9	polished nickel	Zinc	116	29	96	21	133.53.191	\$14.20
10	polished nickel	Zinc	95	27	76 (3")	17	133.53.190	\$12.42
11	polished nickel	Zinc	38	-	-	21	133.53.195	\$19.37
12	polished nickel	Zinc	32	-	-	21	133.53.189	\$10.64

Note

Supplied with 1" mounting screws. Refer to page 265 for matching appliance pulls.

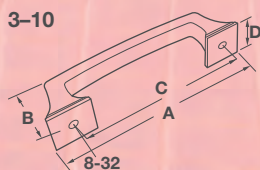
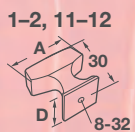



Mulholland

BY AMEROCK

ADA 2-7

	Finish	Material	A	B	C	D	Item No.	SRP/pc.
1	oil-rubbed bronze	Zinc	95	27	76 (3")	17	133.50.348	\$12.42
2	oil-rubbed bronze	Zinc	116	29	96	21	133.50.349	\$14.20
3	oil-rubbed bronze	Zinc	149	32	128	22	133.50.346	\$15.94
4	oil-rubbed bronze	Zinc	181	37	160	22	133.50.347	\$15.84
5	satin nickel	Zinc	181	37	160	22	133.50.351	\$15.84
6	satin nickel	Zinc	149	32	128	22	133.50.350	\$15.94
7	satin nickel	Zinc	116	29	96	21	133.50.353	\$14.20
8	satin nickel	Zinc	95	27	76 (3")	17	133.50.352	\$12.42
9	oil-rubbed bronze	Zinc	32	-	-	21	133.50.611	\$10.64
10	oil-rubbed bronze	Zinc	38	-	-	21	133.50.612	\$19.53

Note

Supplied with 1" mounting screws. Refer to page 265 for matching appliance pulls.

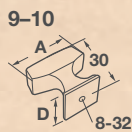
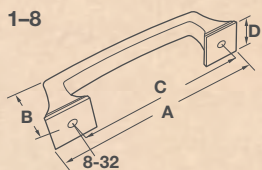

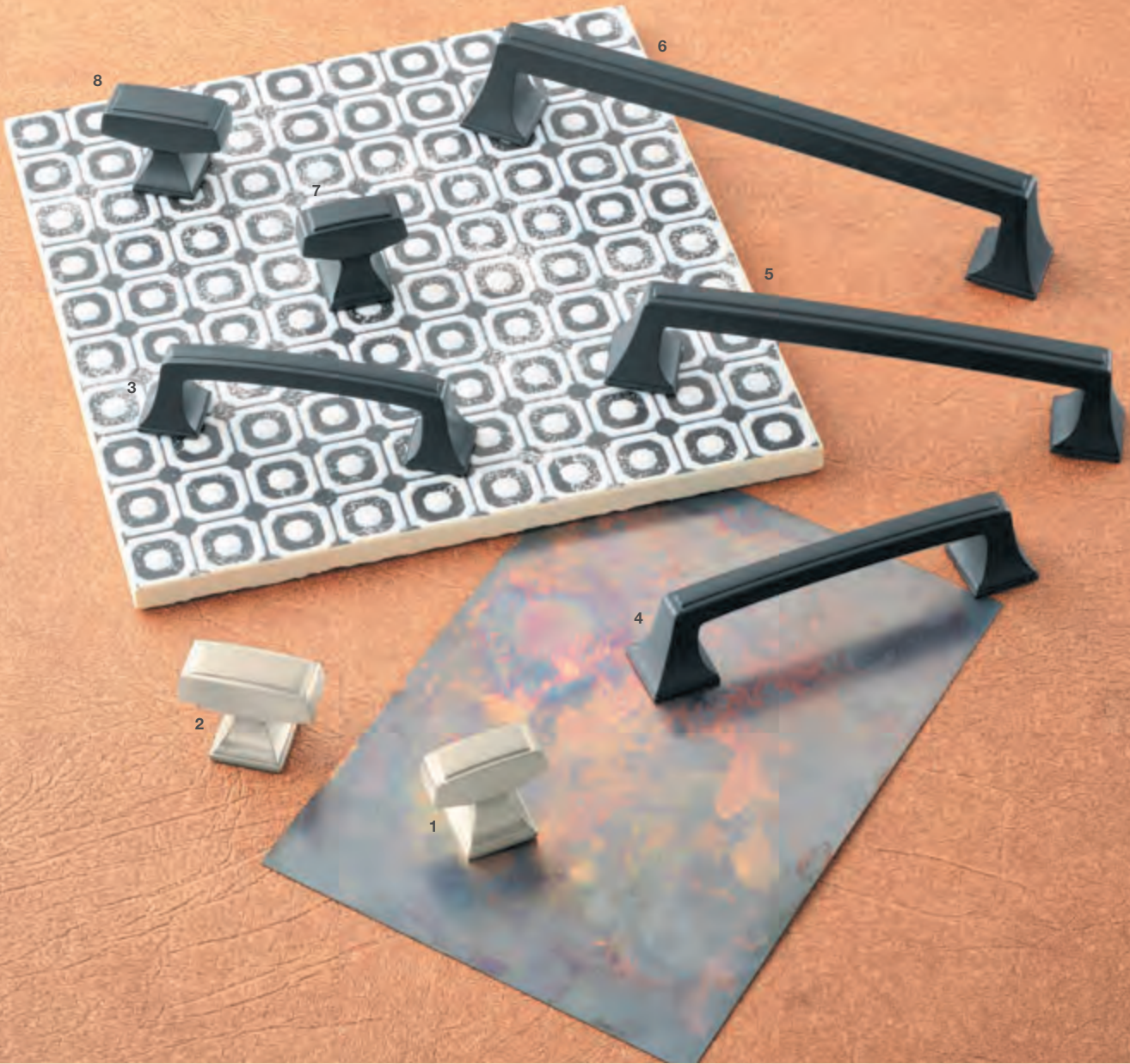

Mulholland

BY AMEROCK

ADA 4-6

	Finish	Material	A	B	C	D	Item No.	SRP/pc.
1	satin nickel	Zinc	32	-	-	21	133.50.613	\$10.64
2	satin nickel	Zinc	38	-	-	21	133.50.614	\$19.53
3	black bronzed	Zinc	95	27	76 (3")	17	133.53.176	\$12.42
4	black bronzed	Zinc	116	29	96	21	133.53.177	\$14.20
5	black bronzed	Zinc	149	32	128	22	133.53.178	\$15.94
6	black bronzed	Zinc	181	37	160	22	133.53.179	\$19.70
7	black bronzed	Zinc	32	-	-	21	133.53.175	\$10.64
8	black bronzed	Zinc	38	-	-	21	133.53.181	\$21.68

Note

Supplied with 1" mounting screws. Refer to page 265 for matching appliance pulls.

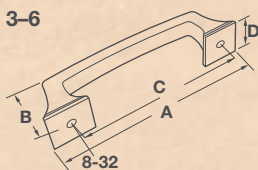
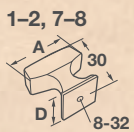



Grace Revitalize

BY AMEROCK

	Finish	Material	A	B	Item No.	SRP/pc.
1	gold champagne	Zinc	35	30	133.50.323	\$14.20
2	gold champagne	Zinc	44	35	133.50.324	\$17.76
3	polished nickel	Zinc	35	30	133.50.327	\$15.77
4	satin nickel	Zinc	35	30	133.50.329	\$14.20
5	polished nickel	Zinc	44	35	133.50.328	\$16.83
6	satin nickel	Zinc	44	35	133.50.330	\$17.76
7	oil-rubbed bronze	Zinc	44	35	133.50.326	\$17.76
8	oil-rubbed bronze	Zinc	35	30	133.50.325	\$14.20

Note
Supplied with 1" mounting screws.

1-8

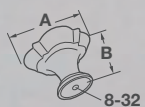



Traditional Classics

BY AMEROCK

	Finish	Material	Item No.	SRP/pc.
1	gold champagne/clear	Zinc/Glass	133.50.127	\$14.23
2	oil-rubbed bronze/clear	Zinc/Glass	133.50.131	\$14.23
3	polished nickel/clear	Zinc/Glass	133.50.132	\$14.23
4	gilded bronze/clear	Zinc/Glass	133.50.130	\$15.84
5	satin nickel/clear	Zinc/Glass	133.50.133	\$14.23
6	black bronzed/clear	Zinc/Glass	133.50.129	\$15.84

Note
Supplied with 1" mounting screws.

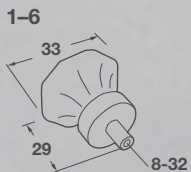

Dimensions in mm unless otherwise noted. Prices subject to change.

TRANSITIONAL

Just right. Not too fancy. Not too edgy. Transitional style is a masterful blend of classic and modern elements that create a setting neither overwhelmed by a single motif nor the clashing of too many styles. Transitional deco provides a bridge for room updates between remodels.





Transitional **NEW**

BY HÄFELE

	Finish	Material	A	C	Item No.	SRP/pc.
1	matt black	Zinc	141	96	106.70.100	\$8.48
2	brushed nickel	Zinc	141	96	106.70.106	\$10.36
3	matt gold	Zinc	141	96	106.70.109	\$11.23
4	matt black	Zinc	205	160	106.70.102	\$10.92
5	brushed nickel	Zinc	205	160	106.70.108	\$13.74
6	matt gold	Zinc	205	160	106.70.111	\$15.21
7	matt gold	Zinc	173	128	106.70.110	\$13.58
8	brushed nickel	Zinc	173	128	106.70.107	\$12.89
9	matt black	Zinc	173	128	106.70.101	\$10.13
10	matt black	Zinc	-	-	106.70.120	\$3.71
11	brushed nickel	Zinc	-	-	106.70.122	\$5.33
12	matt gold	Zinc	-	-	106.70.123	\$6.12

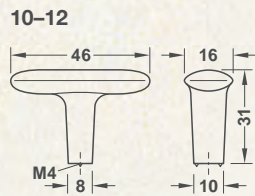
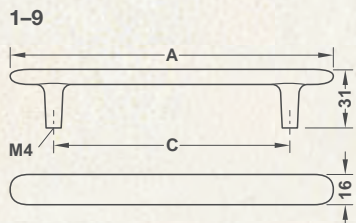



Transitional

	Finish	Material	A	C	Item No.	SRP/pc.
1	brushed nickel	Zinc	-	-	123.08.631	\$20.38
2	brushed nickel	Zinc	177	128	123.08.602	\$18.98
3	brushed nickel	Zinc	120	3"	123.08.610	\$12.26
4	brushed nickel	Zinc	-	-	123.08.641	\$14.16
5	satin nickel	Zinc	-	-	107.04.602	\$33.74
6	stainless steel	Zinc	-	-	103.78.026	\$15.97
7	matt nickel	Zinc	-	-	104.35.600	\$8.77
8	matt nickel	Zinc	-	-	104.37.600	\$4.34

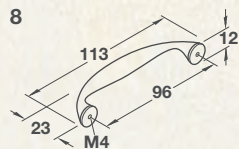
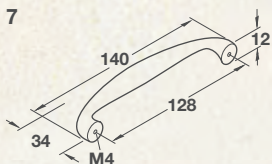
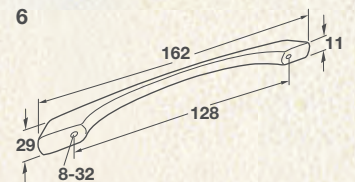
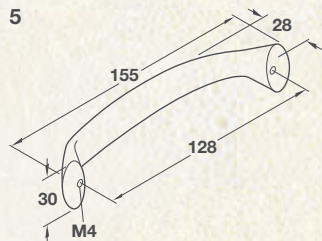
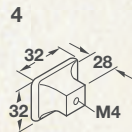
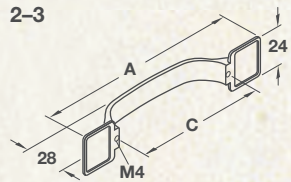
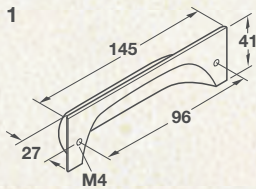

Dimensions in mm unless otherwise noted. Prices subject to change.



Candler

BY AMEROCK

ADA 1, 9-10

	Finish	Material	A	B	C	D	Item No.	SRP/pc.
1	antique silver	Zinc	202	33	160	24	133.50.184	\$14.23
2	antique silver	Zinc	132	30	96	19	133.50.186	\$12.42
3	antique silver	Zinc	38	32	-	32	133.50.238	\$12.42
4	antique silver	Zinc	32	25	-	29	133.50.237	\$8.87
5	oil-rubbed bronze	Zinc	32	25	-	29	133.50.239	\$8.87
6	oil-rubbed bronze	Zinc	38	32	-	32	133.50.240	\$12.42
7	oil-rubbed bronze	Zinc	111	29	76 (3")	19	133.50.189	\$10.64
8	oil-rubbed bronze	Zinc	132	30	96	19	133.50.190	\$12.42
9	oil-rubbed bronze	Zinc	167	32	128	21	133.50.187	\$14.20
10	oil-rubbed bronze	Zinc	202	33	160	24	133.50.188	\$14.23

Note

Supplied with 1" mounting screws. Refer to page 266 for matching appliance pulls.

1-2, 7-10

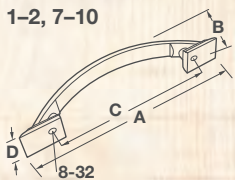

3-6

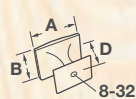



Candler

BY AMEROCK

ADA 2-4, 7

	Finish	Material	A	B	C	D	Item No.	SRP/pc.
1	antique silver	Zinc	111	29	76 (3")	19	133.50.185	\$10.64
2	antique silver	Zinc	167	32	128	21	133.50.183	\$14.20
3	polished nickel	Zinc	202	33	160	24	133.50.192	\$14.23
4	polished nickel	Zinc	167	32	128	21	133.50.191	\$14.20
5	polished nickel	Zinc	132	30	96	19	133.50.194	\$12.42
6	polished nickel	Zinc	111	29	76 (3")	19	133.50.193	\$10.64
7	satin nickel	Zinc	167	32	128	21	133.50.195	\$14.20
8	satin nickel	Zinc	132	30	96	19	133.50.198	\$12.42
9	satin nickel	Zinc	111	29	76 (3")	19	133.50.197	\$10.64

Note

Supplied with 1" mounting screws. Refer to page 266 for matching appliance pulls.

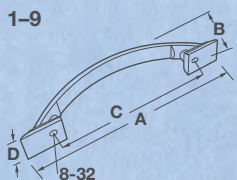

Dimensions in mm unless otherwise noted. Prices subject to change.



Candler

BY AMEROCK

ADA 3

	Finish	Material	A	B	C	D	Item No.	SRP/pc.
1	satin nickel	Zinc	38	32	-	32	133.50.244	\$12.42
2	satin nickel	Zinc	32	25	-	29	133.50.243	\$8.87
3	satin nickel	Zinc	202	24	160	33	133.50.196	\$14.23
4	black bronzed	Zinc	132	19	96	30	133.53.080	\$12.42
5	black bronzed	Zinc	111	19	76 (3")	29	133.53.079	\$10.64
6	black bronzed	Zinc	32	25	-	29	133.53.078	\$8.87
7	polished nickel	Zinc	32	25	-	29	133.50.241	\$8.87
8	polished nickel	Zinc	38	32	-	32	133.50.242	\$12.42

Note

Supplied with 1" mounting screws. Refer to page 266 for matching appliance pulls.

1-2, 6-8

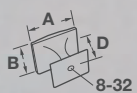

3-5

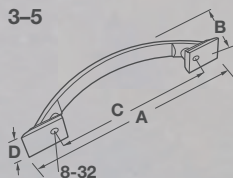



Candler

BY AMEROCK

ADA 6-9

	Finish	Material	A	B	C	D	Item No.	SRP/pc.
1	black bronzed	Zinc	38	32	-	32	133.53.084	\$13.80
2	gold champagne	Zinc	32	25	-	29	133.53.085	\$8.87
3	gold champagne	Zinc	38	32	-	32	133.53.091	\$13.80
4	gold champagne	Zinc	111	19	76 (3")	29	133.53.086	\$10.64
5	gold champagne	Zinc	132	19	96	30	133.53.087	\$12.42
6	gold champagne	Zinc	167	21	128	32	133.53.088	\$14.20
7	gold champagne	Zinc	202	24	160	33	133.53.089	\$17.72
8	black bronzed	Zinc	202	24	160	33	133.53.082	\$17.72
9	black bronzed	Zinc	167	21	128	32	133.53.081	\$14.20

Note

Supplied with 1" mounting screws. Refer to page 266 for matching appliance pulls.

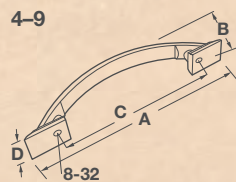
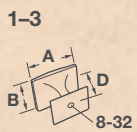

Dimensions in mm unless otherwise noted. Prices subject to change.



Davenport

BY AMEROCK

	Finish	Material	A	B	C	D	Item No.	SRP/pc.
1	gunmetal	Zinc	135	–	96	–	133.50.268	\$20.61
2	gunmetal	Zinc	167	–	128	–	133.50.266	\$22.19
3	gunmetal	Zinc	198	–	160	–	133.50.267	\$23.76
4	oil-rubbed bronze	Zinc	198	–	160	–	133.50.270	\$26.42
5	oil-rubbed bronze	Zinc	167	–	128	–	133.50.269	\$24.67
6	oil-rubbed bronze	Zinc	135	–	96	–	133.50.271	\$22.89
7	gunmetal	Zinc	32	30	–	25	133.50.309	\$15.84
8	gunmetal	Zinc	38	35	–	32	133.50.310	\$18.99

Note
Supplied with 1" mounting screws.

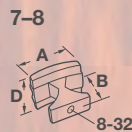
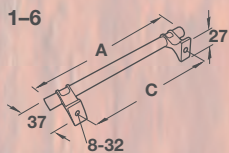



Davenport

BY AMEROCK

	Finish	Material	A	B	C	D	Item No.	SRP/pc.
1	satin nickel	Zinc	198	–	160	–	133.50.273	\$23.76
2	satin nickel	Zinc	167	–	128	–	133.50.272	\$22.19
3	satin nickel	Zinc	135	–	96	–	133.50.274	\$20.61
4	satin nickel	Zinc	32	30	–	25	133.50.313	\$15.84
5	satin nickel	Zinc	38	35	–	32	133.50.314	\$18.99
6	oil-rubbed bronze	Zinc	32	30	–	25	133.50.311	\$17.59
7	oil-rubbed bronze	Zinc	38	35	–	32	133.50.312	\$21.11

Note
Supplied with 1" mounting screws.

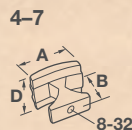
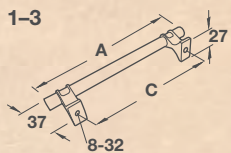

Dimensions in mm unless otherwise noted. Prices subject to change.



St. Vincent

BY AMEROCK

	Finish	Material	A	C	Item No.	SRP/pc.
1	gold champagne	Zinc	160	96	133.50.384	\$20.33
2	gold champagne	Zinc	191	128	133.50.382	\$25.01
3	gold champagne	Zinc	222	160	133.50.383	\$29.59
4	satin nickel	Zinc	222	160	133.50.392	\$30.17
5	satin nickel	Zinc	191	128	133.50.391	\$25.34
6	satin nickel	Zinc	160	96	133.50.393	\$21.14
7	satin nickel	Zinc	-	-	133.50.642	\$15.84
8	gold champagne	Zinc	-	-	133.50.639	\$15.80

Note
Supplied with 1" mounting screws.

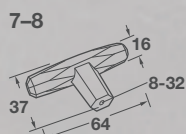
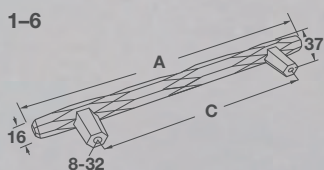



St. Vincent

BY AMEROCK

Finish

- 1 oil-rubbed bronze
- 2 polished nickel
- 3 polished nickel
- 4 polished nickel
- 5 polished nickel
- 6 oil-rubbed bronze
- 7 oil-rubbed bronze
- 8 oil-rubbed bronze

Material

- Zinc
- Zinc
- Zinc
- Zinc
- Zinc
- Zinc
- Zinc
- Zinc

A

-
-
- 160
- 191
- 222
- 222
- 191
- 160

C

-
-
- 96
- 128
- 160
- 160
- 128
- 96

Item No.

- 133.50.640
- 133.50.641
- 133.50.390
- 133.50.388
- 133.50.389
- 133.50.386
- 133.50.385
- 133.50.387

SRP/pc.

- \$15.84
- \$15.80
- \$20.33
- \$25.01
- \$29.59
- \$30.17
- \$25.34
- \$20.61

Note

Supplied with 1" mounting screws.

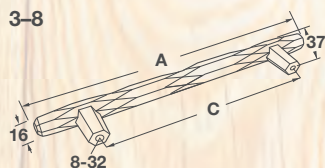
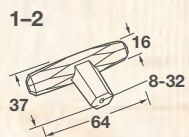

Dimensions in mm unless otherwise noted. Prices subject to change.

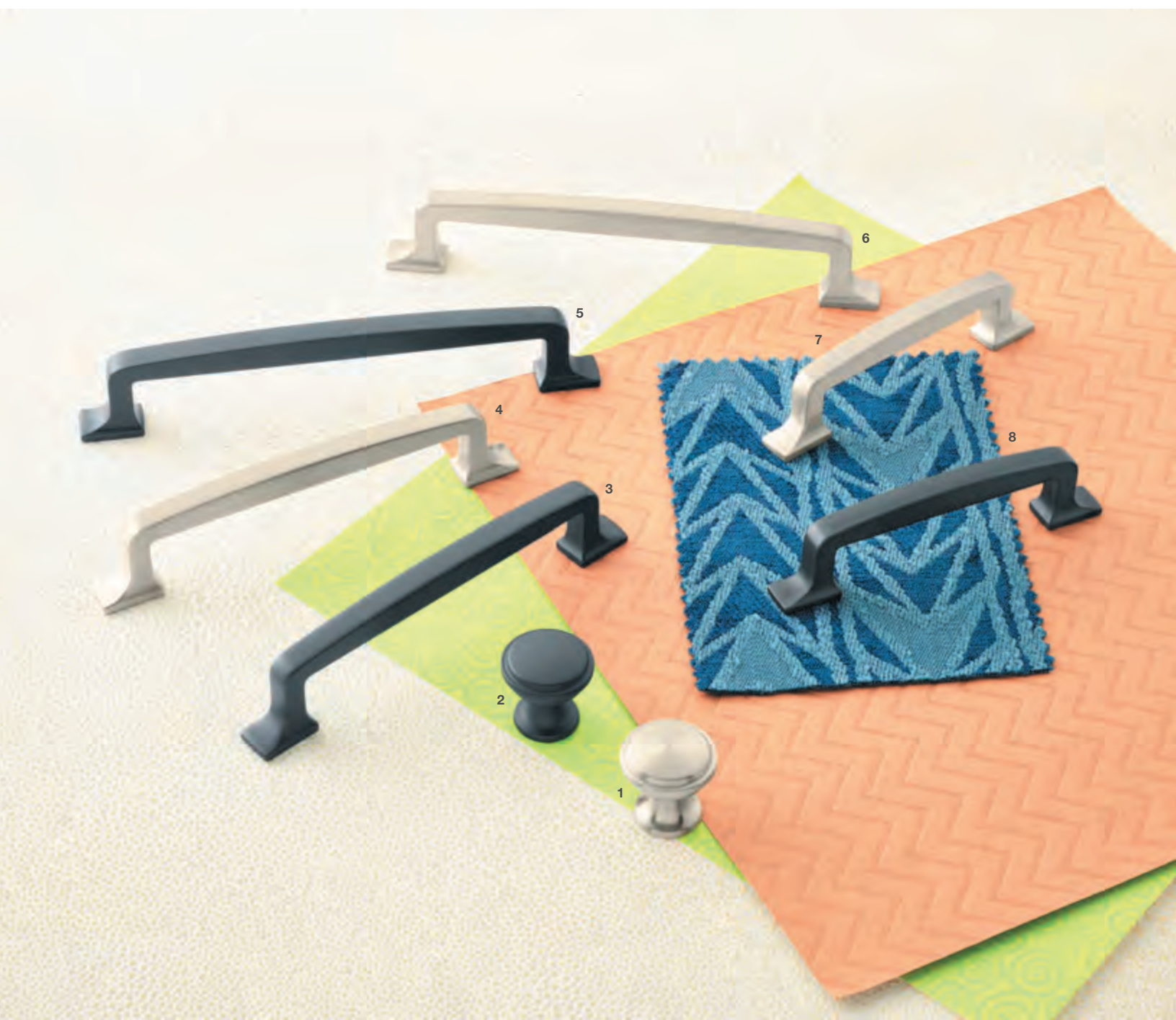

Westerly

BY AMEROCK

ADA 3-8

	Finish	Material	A	B	C	D	Item No.	SRP/pc.
1	satin nickel	Zinc	-	-	-	-	133.50.651	\$9.50
2	black bronzed	Zinc	-	-	-	-	133.53.213	\$9.50
3	black bronzed	Zinc	159	33	128	14	133.53.215	\$14.23
4	satin nickel	Zinc	159	33	128	14	133.50.606	\$14.23
5	black bronzed	Zinc	192	35	160	16	133.53.216	\$17.59
6	satin nickel	Zinc	192	35	160	16	133.50.607	\$15.84
7	satin nickel	Zinc	129	33	96	14	133.50.608	\$12.66
8	black bronzed	Zinc	129	33	96	14	133.53.214	\$12.66

Note

Supplied with 1" mounting screws. Refer to page 267 for matching appliance pulls.

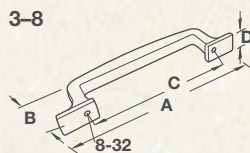
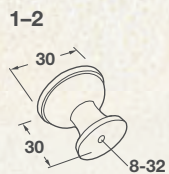



Westerly

BY AMEROCK

ADA 2-4, 6-8

	Finish	Material	A	B	C	D	Item No.	SRP/pc.
1	polished nickel	Zinc	-	-	-	-	133.53.223	\$9.50
2	polished nickel	Zinc	129	33	96	14	133.53.224	\$12.66
3	polished nickel	Zinc	159	33	128	14	133.53.225	\$14.23
4	polished nickel	Zinc	192	35	160	16	133.53.226	\$17.59
5	gold champagne	Zinc	-	-	-	-	133.53.218	\$9.50
6	gold champagne	Zinc	129	33	96	14	133.53.219	\$12.66
7	gold champagne	Zinc	159	33	128	14	133.53.220	\$14.23
8	gold champagne	Zinc	192	35	160	16	133.53.221	\$17.59

Note

Supplied with 1" mounting screws. Refer to page 267 for matching appliance pulls.

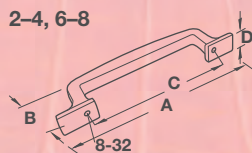
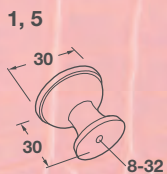



Exceed NEW

BY AMEROCK

ADA 5-8

	Finish	Material	A	C	Item No.	SRP/pc.
1	satin nickel	Zinc	-	-	133.53.500	\$14.23
2	champagne bronze	Zinc	-	-	133.53.329	\$14.23
3	polished chrome	Zinc	-	-	133.53.446	\$15.84
4	matt black	Zinc	-	-	133.53.389	\$12.95
5	matt black	Zinc	249	224	133.53.393	\$40.51
6	satin nickel	Zinc	249	224	133.53.504	\$40.51
7	polished chrome	Zinc	249	224	133.53.450	\$40.51
8	champagne bronze	Zinc	249	224	133.53.333	\$40.51

Note
Supplied with 1" mounting screws.

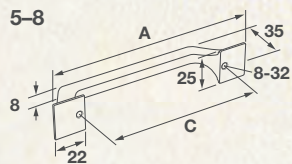
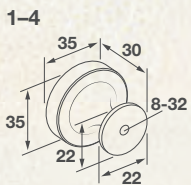



Exceed NEW

BY AMEROCK

ADA

	Finish	Material	A	C	Item No.	SRP/pc.
1	satin nickel	Zinc	133	96	133.53.501	\$20.61
2	satin nickel	Zinc	152	128	133.53.502	\$26.95
3	satin nickel	Zinc	184	160	133.53.503	\$30.17
4	champagne bronze	Zinc	133	96	133.53.330	\$20.61
5	champagne bronze	Zinc	152	128	133.53.331	\$26.95
6	champagne bronze	Zinc	184	160	133.53.332	\$30.17
7	polished chrome	Zinc	133	96	133.53.447	\$22.89
8	polished chrome	Zinc	152	128	133.53.448	\$29.95
9	polished chrome	Zinc	184	160	133.53.449	\$33.48
10	matt black	Zinc	133	96	133.53.390	\$20.61
11	matt black	Zinc	152	128	133.53.391	\$26.95
12	matt black	Zinc	184	160	133.53.392	\$30.17

Note
Supplied with 1" mounting screws.

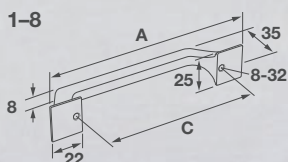



Stature NEW

BY AMEROCK

ADA 7-9

	Finish	Material	A	C	Item No.	SRP/pc.
1	champagne bronze	Zinc	-	-	133.53.298	\$17.59
2	satin nickel	Zinc	-	-	133.53.468	\$17.59
3	matt black	Zinc	-	-	133.53.356	\$17.59
4	champagne bronze	Zinc	-	-	133.53.297	\$11.08
5	satin nickel	Zinc	-	-	133.53.467	\$11.08
6	matt black	Zinc	-	-	133.53.355	\$11.08
7	champagne bronze	Zinc	243	224	133.53.337	\$38.78
8	satin nickel	Zinc	243	224	133.53.508	\$38.78
9	matt black	Zinc	243	224	133.53.397	\$38.78

Note
Supplied with 1" mounting screws.

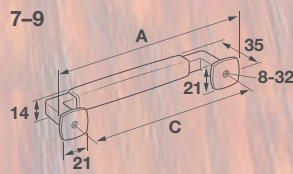
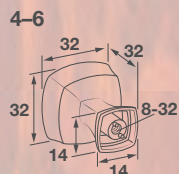
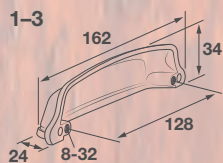



Stature NEW

BY AMEROCK

ADA

	Finish	Material	A	C	Item No.	SRP/pc.
1	champagne bronze	Zinc	116	96	133.53.334	\$18.99
2	champagne bronze	Zinc	148	128	133.53.335	\$25.34
3	champagne bronze	Zinc	179	160	133.53.336	\$28.56
4	matt black	Zinc	116	96	133.53.394	\$18.99
5	matt black	Zinc	148	128	133.53.395	\$23.01
6	matt black	Zinc	179	160	133.53.396	\$28.56
7	satin nickel	Zinc	116	96	133.53.505	\$18.99
8	satin nickel	Zinc	148	128	133.53.506	\$23.01
9	satin nickel	Zinc	179	160	133.53.507	\$28.56

Note
Supplied with 1" mounting screws.

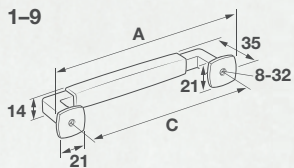

Dimensions in mm unless otherwise noted. Prices subject to change.



Surpass **NEW**

BY AMEROCK

ADA 2-4, 6-8

	Finish	Material	A	C	Item No.	SRP/pc.
1, 5	matt black	Zinc	-	-	133.53.398	\$15.84
2	matt black	Zinc	116	96	133.53.399	\$19.37
3	matt black	Zinc	148	128	133.53.400	\$26.42
4	matt black	Zinc	179	160	133.53.401	\$29.95
5	champagne bronze	Zinc	-	-	133.53.338	\$15.84
6	champagne bronze	Zinc	116	96	133.53.339	\$19.37
7	champagne bronze	Zinc	148	128	133.53.340	\$26.42
8	champagne bronze	Zinc	179	160	133.53.341	\$29.95

Note
Supplied with 1" mounting screws.

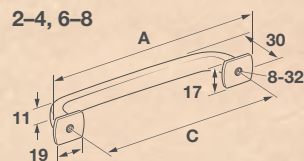
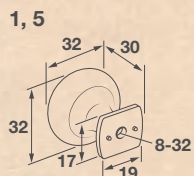



Surpass **NEW**

BY AMEROCK

ADA 2-4, 6-8

	Finish	Material	A	C	Item No.	SRP/pc.
1	satin nickel	Zinc	-	-	133.53.509	\$15.84
2	satin nickel	Zinc	116	96	133.53.510	\$19.37
3	satin nickel	Zinc	148	128	133.53.511	\$26.42
4	satin nickel	Zinc	179	160	133.53.512	\$29.95
5	polished chrome	Zinc	-	-	133.53.451	\$15.84
6	polished chrome	Zinc	116	96	133.53.452	\$19.37
7	polished chrome	Zinc	148	128	133.53.453	\$26.42
8	polished chrome	Zinc	179	160	133.53.454	\$29.95

Note
Supplied with 1" mounting screws.

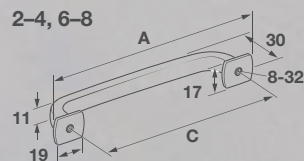
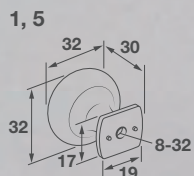

Dimensions in mm unless otherwise noted. Prices subject to change.



Extensity

BY AMEROCK

	Finish	Material	Item No.	SRP/pc.
1	satin nickel	Zinc	133.50.279	\$7.92
2	antique silver	Zinc	133.50.277	\$8.80
3	oil-rubbed bronze	Zinc	133.50.278	\$8.87
4	oil-rubbed bronze	Zinc	133.50.281	\$7.08
5	antique silver	Zinc	133.50.280	\$7.86
6	satin nickel	Zinc	133.50.282	\$7.08

Note
Supplied with 1" mounting screws.

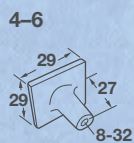
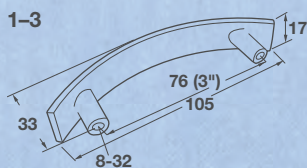



Allison

BY AMEROCK

	Finish	Material	Item No.	SRP/pc.
1	satin nickel	Zinc	133.50.157	\$4.03
2	satin nickel	Zinc	133.50.159	\$5.31
3	oil-rubbed bronze	Zinc	133.50.212	\$4.13
4	black matt	Zinc	133.50.208	\$4.13
5	satin nickel	Zinc	133.50.218	\$4.13
6	satin nickel	Zinc	133.50.217	\$4.74
7	antique silver	Zinc	133.50.205	\$4.74
8	oil-rubbed bronze	Zinc	133.50.211	\$4.74
9	black matt	Zinc	133.50.207	\$4.74
10	polished chrome	Zinc	133.50.215	\$4.74

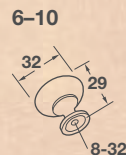
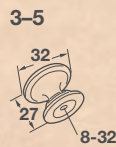
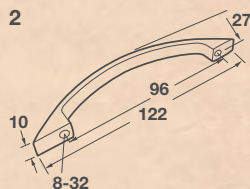
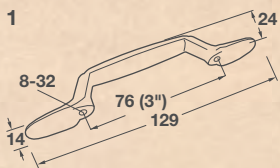

Dimensions in mm unless otherwise noted. Prices subject to change.

CONTEMPORARY

Contemporary styles eschew ornate dust-catchers, or a frilly filigree. Pulls are sleek, simple and direct; 90° angles are the norm. Knobs are guileless; rooted in their pure purpose. Contemporary styles continually evolve and currently showcase stone, wood and matt black finishes while material stalwarts include polished nickel and stainless steel.







Munich NEW

BY HÄFELE

	Finish	Material	A	C	Item No.	SRP/pc.
1	matt gold	Zinc	170	160	110.29.260	\$15.16
2	matt gold	Zinc	330	320	110.29.261	\$25.08
3	polished chrome	Zinc	330	320	110.29.259	\$25.36
4	polished chrome	Zinc	170	160	110.29.256	\$15.16

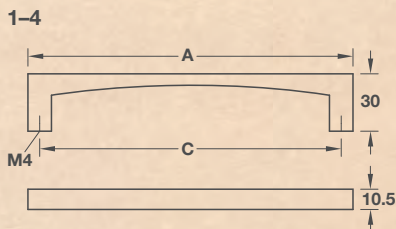



Munich NEW

BY HÄFELE

	Finish	Material	A	C	Item No.	SRP/pc.
1	matt black	Zinc	170	160	110.29.356	\$13.59
2	matt black	Zinc	330	320	110.29.358	\$22.72
3	stainless steel	Zinc	330	320	110.29.659	\$25.36
4	stainless steel	Zinc	170	160	110.29.656	\$15.16

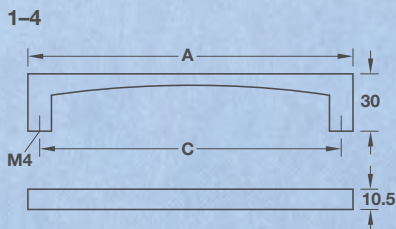

Dimensions in mm unless otherwise noted. Prices subject to change.



Contemporary

BY HÄFELE - 1-4

	Finish	Material	A	B	C	D	Item No.	SRP/pc.
1	polished chrome	Zinc	172	–	160	–	106.69.276	\$16.71
2	brushed nickel	Zinc	172	–	160	–	106.69.676	\$18.32
3	polished chrome	Zinc	204	–	192	–	106.69.277	\$18.95
4	brushed nickel	Zinc	204	–	192	–	106.69.677	\$20.76
5	matt nickel	Zinc	208	33	192	11	109.60.605	\$25.10
6	matt nickel	Zinc	140	32	128	9	109.60.603	\$23.08
7	matt nickel, antimicrobial	Zinc	140	32	128	9	109.60.625	\$16.30
8	matt nickel	Zinc	109	30	96	9	109.60.602	\$20.88

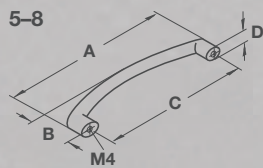
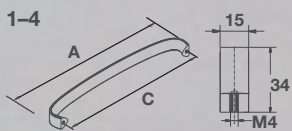



Contemporary

BY HÄFELE - 3-4

	Finish	Material	Item No.	SRP/pc.
1	black matt	Zinc	117.95.330	\$7.74
2	stainless steel look	Zinc	117.95.630	\$11.26
3	brushed nickel	Zinc	110.34.616	\$14.20
4	polished chrome	Zinc	110.34.216	\$14.34
5	matt	Stainless Steel	117.50.610	\$35.90
6	matt nickel	Zinc	110.20.603	\$14.29
7	matt black	Zinc	102.47.319	\$14.38

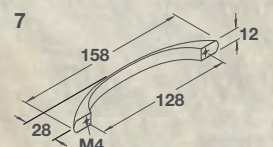
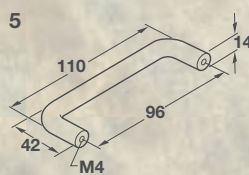
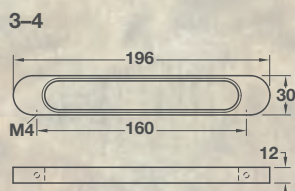
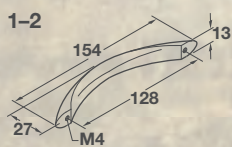

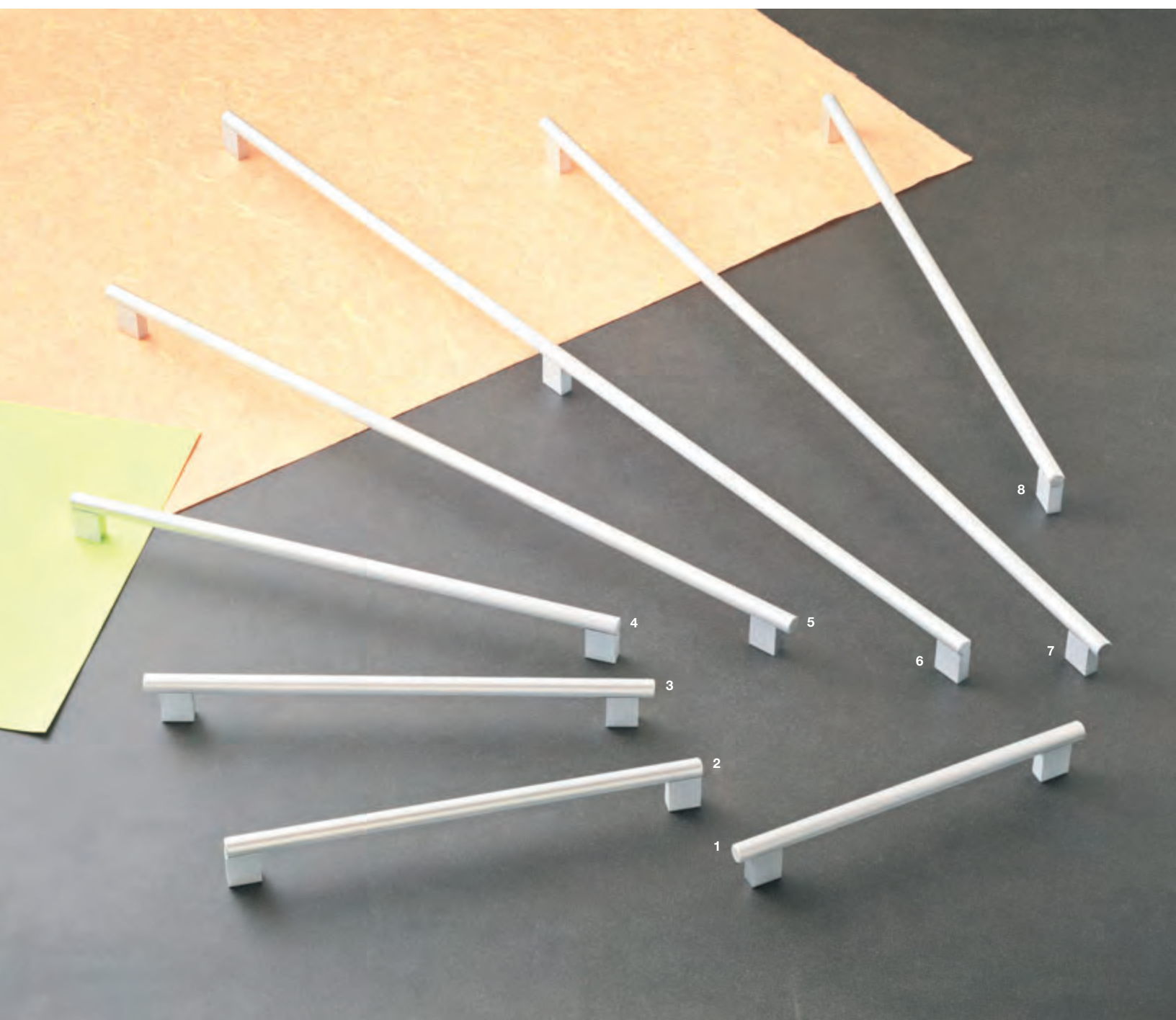

Contemporary



	Finish	Material	A	C	C1	Item No.	SRP/pc.
1	matt aluminum	Aluminum	240	210	-	155.00.984	\$63.18
2	matt aluminum	Aluminum	290	260	-	155.00.985	\$66.80
3	matt aluminum	Aluminum	318	288	-	155.00.986	\$70.42
4	matt aluminum	Aluminum	478	448	-	155.00.991	\$106.88
5	matt aluminum	Aluminum	590	560	-	155.00.993	\$144.84
6	matt aluminum	Aluminum	790	760	380	155.00.995	\$187.08
7	matt aluminum	Aluminum	690	660	-	155.00.994	\$163.44
8	matt aluminum	Aluminum	382	352	-	155.00.988	\$78.30

Note
With loose base, 2 fixing options of handle.

1-5, 7-8

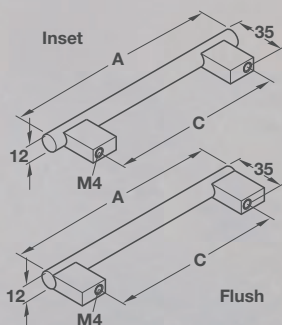

6

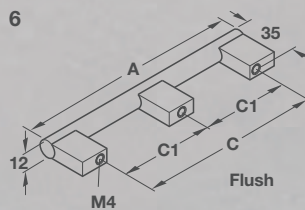

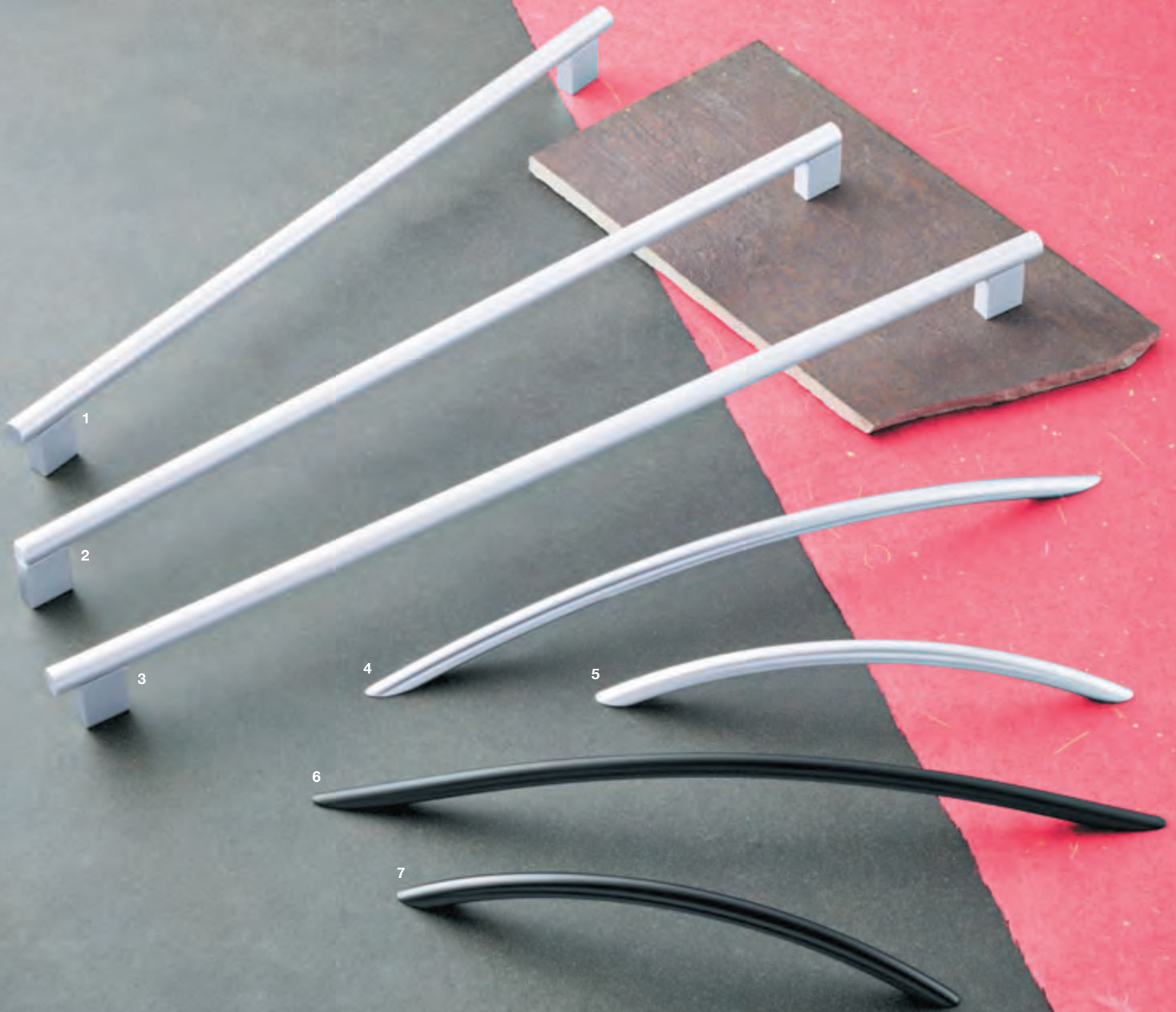

Contemporary



	Finish	Material	A	B	C	Item No.	SRP/pc.
1	matt aluminum	Aluminum	390	-	360	155.00.989	\$113.38
2	matt aluminum	Aluminum	440	-	410	155.00.990	\$111.46
3	matt aluminum	Aluminum	490	-	460	155.00.992	\$129.48
4	matt chrome	Steel	332	31	288	155.00.835	\$15.52
5	matt chrome	Steel	221	32	192	155.00.833	\$11.28
6	black matt	Steel	332	31	288	155.00.885	\$7.72
7	black matt	Steel	221	32	192	155.00.883	\$5.39

Note
1-3 with loose base, 2 fixing options of handle.

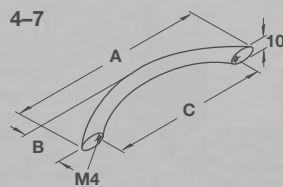
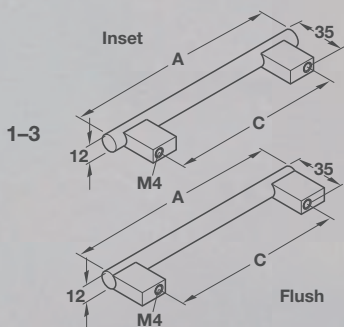



Futura



	Finish	Material	A	C	Item No.	SRP/pc.
1	matt	Stainless Steel 304	141	128	155.01.460	\$17.15
2	matt	Stainless Steel 304	333	320	155.01.465	\$42.66
3	matt	Stainless Steel 304	237	224	155.01.463	\$31.12
4	matt	Stainless Steel 304	205	192	155.01.462	\$27.36
5	matt	Stainless Steel 304	173	160	155.01.461	\$26.76
6	matt	Stainless Steel 304	-	-	155.01.517	\$15.10

1-5

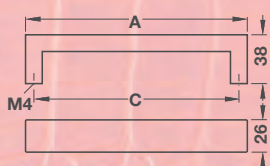

6

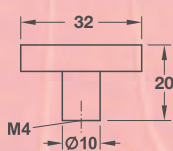



Contemporary



	Finish	Material	A	C	Item No.	SRP/pc.
1	oil-rubbed bronze	Steel	526	456	117.97.359	\$15.85
2	oil-rubbed bronze	Steel	376	306	117.97.358	\$10.93
3	oil-rubbed bronze	Steel	226	156	117.97.357	\$6.27
4	oil-rubbed bronze	Steel	168	128	117.97.352	\$5.63
5	oil-rubbed bronze	Steel	136	96	117.97.351	\$4.95

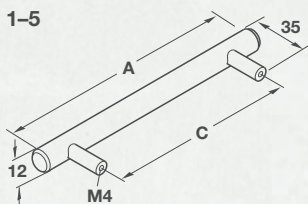

Dimensions in mm unless otherwise noted. Prices subject to change.



Contemporary



	Finish	Material	A	B	C	Item No.	SRP/pc.
1	matt nickel	Steel	138	–	128	155.00.952	\$7.12
2	matt nickel	Steel	106	–	96	155.00.951	\$6.22
3	polished chrome	Steel	112	30	96	155.00.820	\$5.63
4	polished chrome	Steel	148	30	128	155.00.821	\$6.79
5	polished chrome	Steel	184	32	160	155.00.822	\$8.08
6	polished chrome	Steel	221	32	192	155.00.823	\$8.97
7	dark oil-rubbed bronze	Steel	148	30	128	155.00.871	\$10.19
8	dark oil-rubbed bronze	Steel	112	30	96	155.00.870	\$6.56

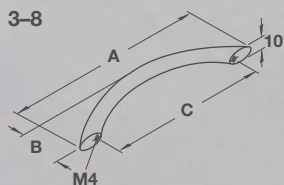
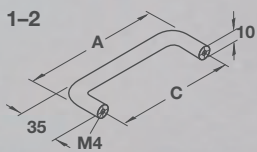



Contemporary



	Finish	Material	A	C	Item No.	SRP/pc.
1	matt	Stainless Steel	107	96	155.01.450	\$19.38
2	matt	Stainless Steel	144	128	155.01.451	\$31.98
3	matt	Stainless Steel	181	160	155.01.452	\$26.59
4	matt	Stainless Steel	218	192	155.01.453	\$30.14
5	matt	Stainless Steel	25	-	134.81.617	\$17.07
6	matt	Stainless Steel	32	-	134.81.626	\$21.92
7	stainless steel look	Zinc	-	-	110.22.001	\$28.12
8	polished chrome	Zinc	-	-	113.96.237	\$27.24

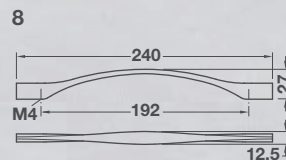
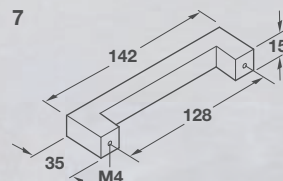
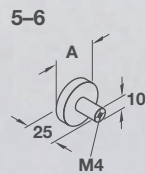
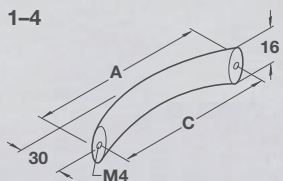

Dimensions in mm unless otherwise noted. Prices subject to change.