

SINK

Innovation through Organization™

Our line of sink base accessories has grown so large that we dedicated an entire chapter to it. We are proud to offer innovative and versatile products, including our Tip-Out Trays, U-Shaped Pullout Shelves and Under Sink Caddies. These popular accessories feature the same superior quality adherent throughout the Rev-A-Shelf product line.

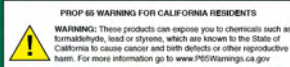



SCAN FOR PRICING!

Waste
Blind Corner
Sink
Base
Tall
Drawer
Wall
Vanity
Closet
Lazy Susan
LED Lighting

- Designed for 36" sink base cabinets
- Single polyethylene container with handle - black, orion gray or white
- Mounts to cabinet door



5CCSO12-13-1

BAR WIDTH
13" (330 mm)



5CCSO12-18-1
Cleaning Caddy
(Black finish shown)



5CCSO12-11-1
Cleaning Caddy
(White finish shown)



Included mounting bar for installation on a 5-panel door



For video visit:
rev-a-shelf.com/videos

Wire Door Mount Cleaning Caddy

PRODUCT	DESCRIPTION	DIMS	MCO	CAB	FINISH	SLP
5CCSO12-11-1	Cleaning Caddy	9-3/4 - 13" (248 - 330 mm) W x 9-23-32" (247 mm) D x 8-1/4" (210 mm) H	15" (305 mm)	SB36	White	\$24.65
5CCSO12-13-1	Cleaning Caddy	9-3/4 - 13" (248 - 330 mm) W x 9-23-32" (247 mm) D x 8-1/4" (210 mm) H	15" (305 mm)	SB36	Orion Gray	\$24.80
5CCSO12-18-1	Cleaning Caddy	9-3/4 - 13" (248 - 330 mm) W x 9-23-32" (247 mm) D x 8-1/4" (210 mm) H	15" (305 mm)	SB36	Black	\$24.65



SCAN FOR PRICING!

Cleaning Caddy Pullout

5CC Series

Waste

Blind Corner

Sink

Base

Tall

Drawer

Wall

Vanity

Closet

Lazy Susan

LED Lighting



- Designed for 30" sink base cabinets
- Single polyethylene container with handle - black, orion gray or white
- Full-extension, under mount, 75 lb. rated, concealed slides with soft-close
- Mounts to cabinet floor
- (2) 1 L spray bottles with removable storage rack
- Door mount kit available (sold separately)

5CC-915S-18-1



5CC-915S-13-1
Cleaning Caddy Pullout
(Black finish shown)



5CC-915S-11-1
Cleaning Caddy Pullout
(White finish shown)



For video visit:
rev-a-shelf.com/videos

Sink Base 2-in-1 Polyethylene Cleaning Pullout w/ (2) Spray Bottles and Soft-Close

PRODUCT	DESCRIPTION	DIMS	MCO	CAB	FINISH	SLP
5CC-915S-11-1	Cleaning Caddy Pullout	9-1/4" (235 mm) W x 18-19/32" (472 mm) D x 18-1/2" (471 mm) H	9-1/2" (241 mm)	SB30	White	\$183.85
5CC-915S-13-1	Cleaning Caddy Pullout	9-1/4" (235 mm) W x 18-19/32" (472 mm) D x 18-1/2" (471 mm) H	9-1/2" (241 mm)	SB30	Orion Gray	\$183.85
5CC-915S-18-1	Cleaning Caddy Pullout	9-1/4" (235 mm) W x 18-19/32" (472 mm) D x 18-1/2" (471 mm) H	9-1/2" (241 mm)	SB30	Black	\$183.85
Accessories						
5WB-DMKIT	Door Mount Kit				Chrome	\$42.35



SCAN FOR PRICING!

Waste

Blind Corner

Sink

Base

Tall

Drawer

Wall

Vanity

Closet

Lazy Susan

LED Lighting

Door Mount

- Designed for 30" sink base (butt door) cabinets
- Wire construction, powder-coated white or chrome-plated
- Mounts to cabinet door
- Holds up to (3) dish towels

Pullout

- Designed for base or sink base cabinets
- Wire construction, powder-coated white or chrome-plated
- Full-extension friction slide or 3/4 extension, ball-bearing, 25 lb. rated slide (563-51-C only)
- Universal mounting, non-handed
- Mounts to cabinet side walls
- Holds up to (2) or (3) dish towels



563-47 C



563-32 C
Door Mount Towel Holder
(Chrome finish shown)



563-51 C
2-Prong Pullout Towel Holder
(Chrome finish shown)

Door Mount Towel Holder						
PRODUCT	DESCRIPTION	DIMS	MCO	CAB	FINISH	SLP
563-32	Towel Holder	12-3/4" (324 mm) W x 3-1/2" (89 mm) D x 6-1/2" (165 mm) H	13" (330 mm) - FF 13" (330 mm) - FL	SB30	White	\$6.95
563-32 C	Towel Holder	12-3/4" (324 mm) W x 3-1/2" (89 mm) D x 6-1/2" (165 mm) H	13" (330 mm) - FF 13" (330 mm) - FL	SB30	Chrome	\$7.70
Pullout Towel Holder w/ Ball-bearing Slide						
563-51-C	2-Prong Towel Holder	3-7/8" (98 mm) W x 12-7/8" (327 mm) D x 1-1/2" (38 mm) H	5" (127 mm)		Chrome	\$38.70
Pullout Towel Holder w/ Friction Slide						
563-47	3-Prong Towel Holder	5" (127 mm) W x 17-3/4" (451 mm) D x 1-1/4" (32 mm) H	6" (152 mm)		White	\$36.70
563-47 C	3-Prong Towel Holder	5" (127 mm) W x 17-3/4" (451 mm) D x 1-1/4" (32 mm) H	6" (152 mm)		Chrome	\$40.90



SCAN FOR PRICING!

Polymer Drip Tray

SBDT Series



- Designed for installation in new 30", 36" and 42" sink base cabinet construction
- Can be cut down to fit a 27", 33" or 39" cabinet
- Protects the bottom of your cabinet from spills
- Funnels excessive water out of the front of your cabinet
- Orion gray, almond or metallic silver



OG: Orion Gray, S: Metallic Silver, A: Almond

Tray Capacity	
SBDT-2730	1-1/2 qt.
SBDT-3336	1-3/4 qt.
SBDT-3942	2-1/5 qt.

See page 277 for vanity version

Drip Tray							
PRODUCT	DESCRIPTION	DIMS	MIN TRIM	CAB	FINISH	SLP	
SBDT-2730-OG-1	Drip Tray	28-1/2" (724 mm) W x 23-1/4" (591 mm) D x 3/4" (19 mm) H	25-1/2" (648 mm) x 21-1/2" (546 mm)	SB27-30	Orion Gray	\$74.80	
SBDT-2730-A-1	Drip Tray	28-1/2" (724 mm) W x 23-1/4" (591 mm) D x 3/4" (19 mm) H	25-1/2" (648 mm) x 21-1/2" (546 mm)	SB27-30	Almond	\$64.95	
SBDT-2730-S-1	Drip Tray	28-1/2" (724 mm) W x 23-1/4" (591 mm) D x 3/4" (19 mm) H	25-1/2" (648 mm) x 21-1/2" (546 mm)	SB27-30	Metallic Silver	\$71.20	
SBDT-3336-OG-1	Drip Tray	34-1/2" (876 mm) W x 23-1/4" (591 mm) D x 3/4" (19 mm) H	31-1/2" (800 mm) x 21-1/2" (546 mm)	SB33-36	Orion Gray	\$82.65	
SBDT-3336-A-1	Drip Tray	34-1/2" (876 mm) W x 23-1/4" (591 mm) D x 3/4" (19 mm) H	31-1/2" (800 mm) x 21-1/2" (546 mm)	SB33-36	Almond	\$72.20	
SBDT-3336-S-1	Drip Tray	34-1/2" (876 mm) W x 23-1/4" (591 mm) D x 3/4" (19 mm) H	31-1/2" (800 mm) x 21-1/2" (546 mm)	SB33-36	Metallic Silver	\$79.45	
SBDT-3942-OG-1	Drip Tray	40-1/2" (1029 mm) W x 23-1/4" (591 mm) D x 3/4" (19 mm) H	37-1/2" (953 mm) x 21-1/2" (546 mm)	SB39-42	Orion Gray	\$87.15	
SBDT-3942-A-1	Drip Tray	40-1/2" (1029 mm) W x 23-1/4" (591 mm) D x 3/4" (19 mm) H	37-1/2" (953 mm) x 21-1/2" (546 mm)	SB39-42	Almond	\$79.45	
SBDT-3942-S-1	Drip Tray	40-1/2" (1029 mm) W x 23-1/4" (591 mm) D x 3/4" (19 mm) H	37-1/2" (953 mm) x 21-1/2" (546 mm)	SB39-42	Metallic Silver	\$87.45	
(12) Drip Trays							
SBDT-2730-A-12	Drip Tray	28-1/2" (724 mm) W x 23-1/4" (591 mm) D x 3/4" (19 mm) H	25-1/2" (648 mm) x 21-1/2" (546 mm)	SB27-30	Almond	\$55.55 ea.	
SBDT-2730-S-12	Drip Tray	28-1/2" (724 mm) W x 23-1/4" (591 mm) D x 3/4" (19 mm) H	25-1/2" (648 mm) x 21-1/2" (546 mm)	SB27-30	Metallic Silver	\$61.05 ea.	
SBDT-3336-A-12	Drip Tray	34-1/2" (876 mm) W x 23-1/4" (591 mm) D x 3/4" (19 mm) H	31-1/2" (800 mm) x 21-1/2" (546 mm)	SB33-36	Almond	\$61.65 ea.	
SBDT-3336-S-12	Drip Tray	34-1/2" (876 mm) W x 23-1/4" (591 mm) D x 3/4" (19 mm) H	31-1/2" (800 mm) x 21-1/2" (546 mm)	SB33-36	Metallic Silver	\$67.85 ea.	
SBDT-3942-A-12	Drip Tray	40-1/2" (1029 mm) W x 23-1/4" (591 mm) D x 3/4" (19 mm) H	37-1/2" (953 mm) x 21-1/2" (546 mm)	SB39-42	Almond	\$67.85 ea.	
SBDT-3942-S-12	Drip Tray	40-1/2" (1029 mm) W x 23-1/4" (591 mm) D x 3/4" (19 mm) H	37-1/2" (953 mm) x 21-1/2" (546 mm)	SB39-42	Metallic Silver	\$74.40 ea.	

Waste
Blind Corner
Sink
Base
Tall
Drawer
Wall
Vanity
Closet
Susan
Lazy
LED Lighting



SCAN FOR PRICING!

- Designed for wood, glass, metal and particle board cabinets
- White polymer construction, additional colors available with bulk order
- Powerful magnetic locks to keep doors closed
- Unlocking key that disables lock only when you want

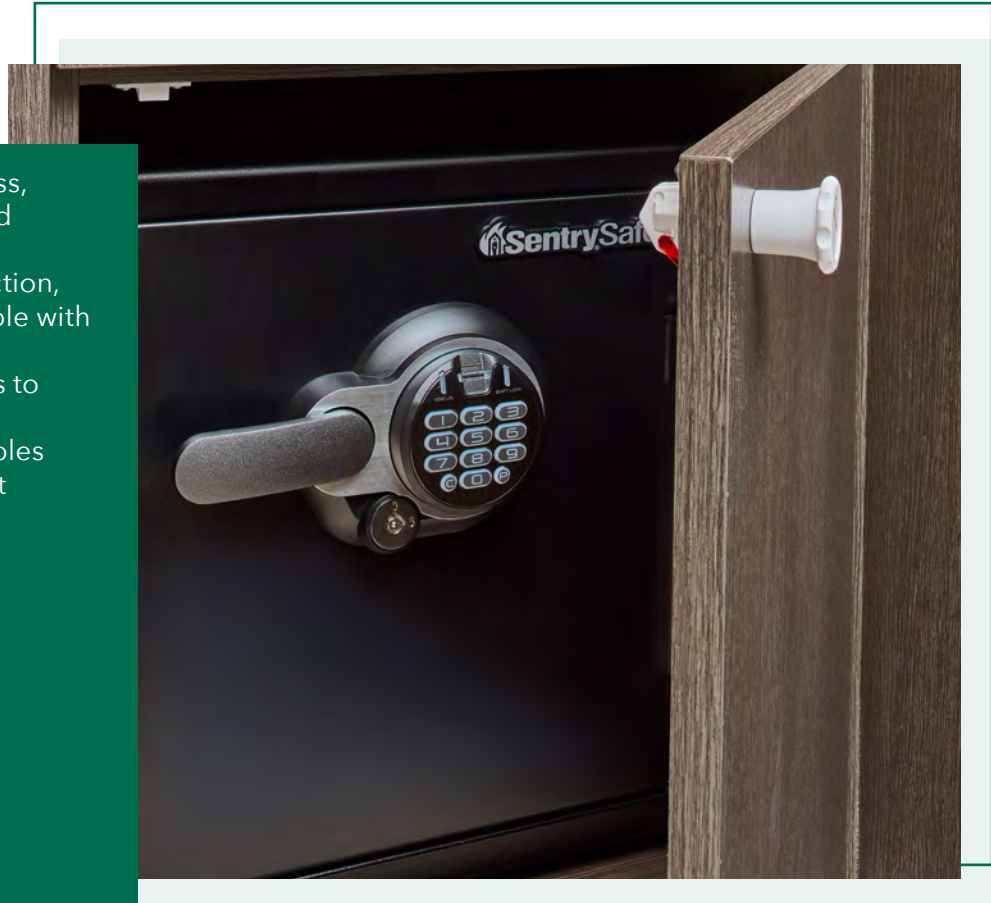

RAL-101-1



RAL-101-1
Rev-A-Lock® Starter Set
(Polymer finish shown)



For video visit:
rev-a-shelf.com/videos

NOTE: The lock will install on thickness of 1/2" (13 mm) to 19/16" (40 mm) and operate through wood, glass, metal and particle board.

- Additional colors available via special order (min. 500). Contact your Sales Rep for more information.

Rev-A-Lock® Cabinet Security

PRODUCT	DESCRIPTION	DIMS	FINISH	SLP
RAL-101-1	Starter Set (5 Locks & 2 Keys)	1-3/16" (31 mm) W x 1-5/8" (42 mm) D x 1-3/8" (36 mm) H	Polymer	\$71.65
RL-201-1	Lock Assembly	1-3/16" (31 mm) W x 1-5/8" (42 mm) D x 1-3/8" (36 mm) H	Polymer	\$12.20
RL-202-1	Magnetic Key	1-15/32" (37 mm) W x 1-15/32" (37 mm) D x 1-1/4" (32 mm) H	Polymer	\$16.40



SCAN FOR PRICING!

Door Storage Tray Set

6230 Series

Waste

Blind Corner

Sink

Base

Tall

Drawer

Wall

Vanity

Closet

Lazy Susan

LED Lighting



- (2) or (5) 8", 14" and 20" trays
- Glossy polymer construction, almond or white
- Mounts to cabinet door
- Trays can also be mounted to 26" or 58" aluminum standards (sold separately)
- Screw-in clips included, standards available (sold separately)

6232-14-11-52



Bracket extension kit, sold separately



6232-14-11-52
Polymer Door Storage Tray
(14" version shown)

NOTE: **Insert 11 for White finish or 15 for Almond finish

Door Storage Tray Set w/ Screw-In Clips

PRODUCT	DESCRIPTION	DIMS	MCO	CAB	FINISH	SLP
6232-08-**-52	Trays w/ Screw-In Clips	7-7/8" (200 mm) W x 4-1/4" (110 mm) D x 3-9/16" (95 mm) H	9" (229 mm) - FF 9" (229 mm) - FL	B12	Polymer	\$29.15/set
6232-14-**-52	Trays w/ Screw-In Clips	13-3/4" (350 mm) W x 4-1/4" (110 mm) D x 3-9/16" (95 mm) H	14-1/2" (368 mm) - FF 14-1/2" (368 mm) - FL	B18	Polymer	\$31.45/set
6232-20-**-52	Trays w/ Screw-In Clips	19-3/4" (502 mm) W x 4-1/4" (110 mm) D x 3-9/16" (95 mm) H	20-1/2" (521 mm) - FF 20-1/2" (521 mm) - FL	B24	Polymer	\$39.60/set

(5) Tray Sets with Clips

6235-08-**-52	Trays w/ Screw-In Clips	7-7/8" (200 mm) W x 4-1/4" (110 mm) D x 3-9/16" (95 mm) H	9" (229 mm) - FF 9" (229 mm) - FL	B12	Polymer	\$68.75/set
6235-14-**-52	Trays w/ Screw-In Clips	13-3/4" (350 mm) W x 4-1/4" (110 mm) D x 3-9/16" (95 mm) H	14-1/2" (368 mm) - FF 14-1/2" (368 mm) - FL	B18	Polymer	\$74.65/set
6235-20-**-52	Trays w/ Screw-In Clips	19-3/4" (502 mm) W x 4-1/4" (110 mm) D x 3-9/16" (95 mm) H	20-1/2" (521 mm) - FF 20-1/2" (521 mm) - FL	B24	Polymer	\$90.20/set

6230-MB-11-1	Mounting Bracket Extension Kit				Polymer	\$15.95
--------------	--------------------------------	--	--	--	---------	---------

Accessories

6230-MB-11-1	Mounting Bracket Extension Kit				White	\$15.95
6232-26-4528-52	Pair Aluminum Standards w/ (4) Clips	26" (660 mm) L			Alum	\$64.10
6232-58-4528-52	Pair Aluminum Standards w/ (10) Clips	58" (1473 mm) L			Alum	\$98.15



SCAN FOR PRICING!

Waste
Blind Corner
Sink
Base
Tall
Drawer
Wall
Vanity
Closet
Lazy Susan
LED Lighting

- 22", 24" and 30-1/2" trays, almond or white
- Bulk trays available
- Mounts to sink front panels
- (1) pair of 45-degree LD pivot hinges

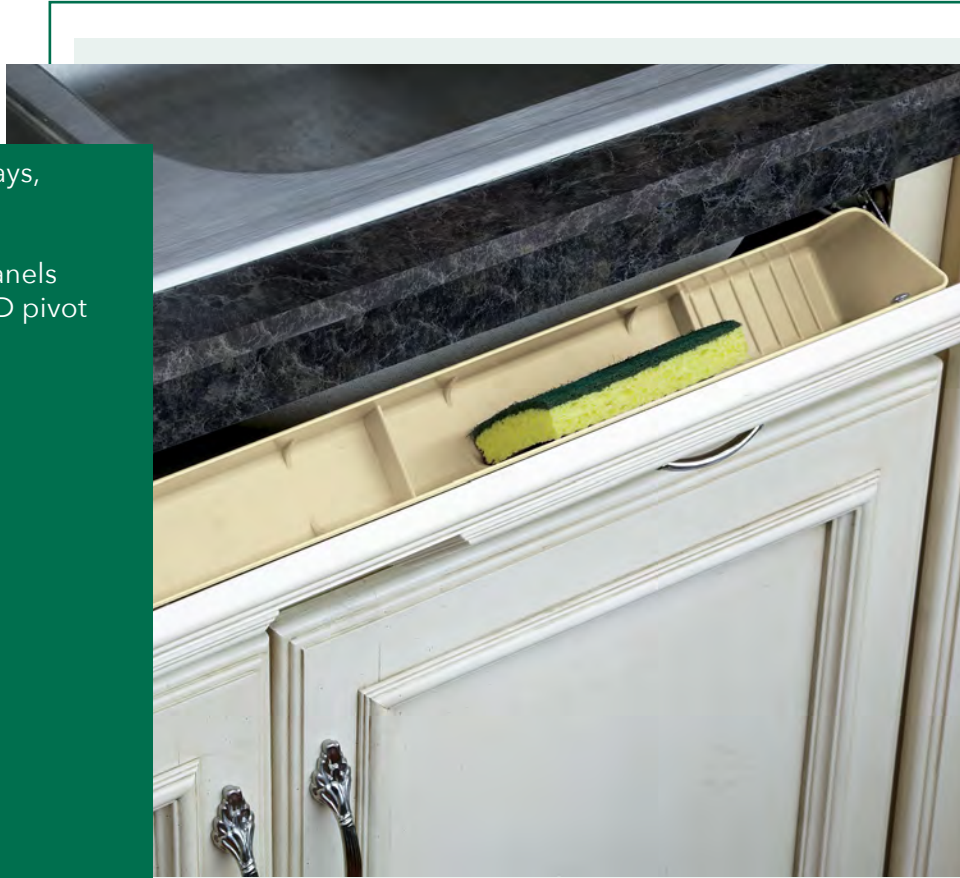

LD-6591-24-15-1



For video visit:
rev-a-shelf.com/videos



LD-6591-22-11-1
22" Deluxe Tip-Out Tray w/ Hinges
(White finish shown)



LD-6591-30-15-1
30" Deluxe Tip-Out Tray w/ Hinges
(Almond finish shown)

NOTE: Sink Front Trays can also be installed into Vanity Sink Base Cabinets! **Insert 11 for White finish or 15 for Almond finish

Deluxe Tip-Out Tray System (Std./Acc.)

PRODUCT	DESCRIPTION	DIMS	FINISH	SLP
LD-6591-22-**-1	Deluxe Tip-Out Tray w/ 45° Hinges	22" (559 mm) W x 2-1/8" (54 mm) D x 3-13/16" (97 mm) H	Polymer	\$23.35/set
LD-6591-24-**-1	Deluxe Tip-Out Tray w/ 45° Hinges	24" (610 mm) W x 2-1/8" (54 mm) D x 3-13/16" (97 mm) H	Polymer	\$25.10/set
LD-6591-30-**-1	Deluxe Tip-Out Tray w/ 45° Hinges	30-7/16" (774 mm) W x 2-1/8" (54 mm) D x 3-13/16" (97 mm) H	Polymer	\$30.00/set
Bulk Deluxe Tip-Out Trays Only				
LD-6591-22-**-10	(10) Deluxe Tip-Out Trays Only	22" (559 mm) W x 2-1/8" (54 mm) D x 3-13/16" (97 mm) H	Polymer	\$12.75 ea.
LD-6591-24-**-10	(10) Deluxe Tip-Out Trays Only	24" (610 mm) W x 2-1/8" (54 mm) D x 3-13/16" (97 mm) H	Polymer	\$12.90 ea.
LD-6591-30-**-10	(10) Deluxe Tip-Out Trays Only	30-7/16" (774 mm) W x 2-1/8" (54 mm) D x 3-13/16" (97 mm) H	Polymer	\$15.95 ea.



SCAN FOR PRICING!

36" Sink Front Tip-Out Trays

65** Series

Waste

Blind Corner

Sink

Base

Tall

Drawer

Wall

Vanity

Closet

Lazy Susan

LED Lighting



- 36" or 72" trays, almond or white
- Trimmable to desired length
- Molded polymer end caps
- Key-shaped holes for easy removal and cleaning
- Can be used as a tip-out tray or a spice rack

6551-36-11-52



6551-36-11-50
36" Tip-Out Tray w/ Hinges & End Caps
(White finish shown)



6551-36-15-52
36" Tip-Out Tray w/ Hinges & End Caps
(Almond finish shown)



For video visit:
rev-a-shelf.com/videos

NOTE: **6552 Series End cap/Hinge sets are individually poly-bagged, bulk packed.

Sink Front Trays can also be installed into Vanity Sink Base Cabinets! **Insert 11 for White finish or 15 for Almond finish

36" Tray with Hinges and End Caps

PRODUCT	DESCRIPTION	DIMS	FINISH	SLP
6551-36-**-52	1 Tray - 2 Pair Hinges & End Caps	36" (914 mm) W x 2-7/16" (62 mm) D x 3-15/16" (100 mm) H	Polymer	\$52.50
6551-36-**-50	1 Tray - 1 Pair Hinges & End Caps	36" (914 mm) W x 2-7/16" (62 mm) D x 3-15/16" (100 mm) H	Polymer	\$35.50
6551-36-**-ETH	1 Tray - 1 Pair Hinges & End Caps	36" (914 mm) W x 2-7/16" (62 mm) D x 3-15/16" (100 mm) H	Polymer	\$50.75

Bulk Components

6552-97-**-4	(40) Hinges, End Caps, Inst. & Adhesive		Polymer	\$16.95 pr.
6552-ETH-**-10	(10) Hinges, End Caps, Inst. & Adhesive		Polymer	\$26.40 pr.
6571-36-**-4	(20) Trays ONLY	36" (914 mm) W x 2-7/16" (62 mm) D x 3-15/16" (100 mm) H	Polymer	\$16.80 ea.
6571-72-**-4	(20) Trays ONLY	72" (1829 mm) W x 2-7/16" (62 mm) D x 3-15/16" (100 mm) H	Polymer	\$39.75 ea.

Components for Tip-Out or Spice Tray Applications

ST-97-**-4	(40) End Caps, Screws			\$9.70 pr.
6571-60-52	Tube of Adhesive	2 Grams		\$7.40
6571-61-52	Bottle of Adhesive	1 Ounce		\$38.15

65** Series

Sink Front Tip-Out Trays



SCAN FOR PRICING!



6572-11-11-52

Standard and Accessory Tray
(White finish shown)



Ring Post

6572-11-11-52

- (1) or (20) 11" or 14" tray sets
- Glossy polymer construction, almond or white
- Each set: (1) standard tray, (1) accessory tray with ring holder and soap dish
- Mounts to sink front panels
- (2) pair of Self-Holdin® hinges (US Patent No. 7,635,171)
- Bulk (40) 11" or 14" standard or accessory trays ONLY available

NOTE: Sink Front Trays can also be installed into Vanity Sink Base Cabinets! **Insert 11 for White finish or 15 for Almond finish

Sink Front Tip-Out Tray System (Std./Acc.)

PRODUCT	DESCRIPTION	DIMS	FINISH	SLP
6572-11-**-52	Std/Acc Trays with Hinges	11" (280 mm) W x 2-1/8" (54 mm) D x 3-13/16" (97 mm) H	Polymer	\$34.95
6572-14-**-52	Std/Acc Trays with Hinges	14" (356 mm) W x 2-1/8" (54 mm) D x 3-13/16" (97 mm) H	Polymer	\$35.10

(20) False Front Tip-Out Tray System (Std./Acc.)

6572-11-**-4	(20) Std/Acc Trays with Hinges	11" (280 mm) W x 2-1/8" (54 mm) D x 3-13/16" (97 mm) H	Polymer	\$32.05 ea.
6572-14-**-4	(20) Std/Acc Trays with Hinges	14" (356 mm) W x 2-1/8" (54 mm) D x 3-13/16" (97 mm) H	Polymer	\$32.20 ea.

(40) False Front Tip-Out Trays

6581-11-**-4	(40) Standard Trays	11" (280 mm) W x 2-1/8" (54 mm) D x 3-13/16" (97 mm) H	Polymer	\$7.70 ea.
6581-14-**-4	(40) Standard Trays	14" (356 mm) W x 2-1/8" (54 mm) D x 3-13/16" (97 mm) H	Polymer	\$7.70 ea.
6591-11-**-4	(40) Accessory Trays	11" (280 mm) W x 2-1/8" (54 mm) D x 3-13/16" (97 mm) H	Polymer	\$7.70 ea.
6591-14-**-4	(40) Accessory Trays	14" (356 mm) W x 2-1/8" (54 mm) D x 3-13/16" (97 mm) H	Polymer	\$7.70 ea.

Tip-Out Trays with Tab Stops

- Affordable alternative to the conventional tray systems
- Features high-resistant tabs to prevent breaking



6562-11-11-52
Tray with Tab Stops
(White finish shown)



6562-14-15-52
Tray with Tab Stops
(Almond finish shown)

**Insert 11 for White finish or 15 for Almond finish

Trays with Tab Stops

PRODUCT	DESCRIPTION	DIMS	FINISH	SLP
6562-11-**-52	11" Trays with Tab Stops	12-1/2" (318 mm) W x 2-1/8" (54 mm) D x 3-13/16" (97 mm) H	Polymer	\$21.60
6562-14-**-52	14" Trays with Tab Stops	15-1/2" (394 mm) W x 2-1/8" (54 mm) D x 3-13/16" (97 mm) H	Polymer	\$22.75

(40) Trays with Tab Stops

6561-11-**-4	11" Trays with Tab Stops	12-1/2" (318 mm) W x 2-1/8" (54 mm) D x 3-13/16" (97 mm) H	Polymer	\$7.25 ea.
6561-14-**-4	14" Trays with Tab Stops	15-1/2" (394 mm) W x 2-1/8" (54 mm) D x 3-13/16" (97 mm) H	Polymer	\$7.25 ea.



SCAN FOR PRICING!

Slim Sink Front Tip-Out Trays

654* Series



6541-36-11-4

Custom cut trays to length and glue end caps on with included glue. Note: 1-Year warranty. Store unused glue at 40° or below.



- 11" or 14" solid or extruded trays, almond or white
- Trim-to-fit
- Designed to accommodate minimum clearance openings
- Perfect for hiding sponges and scouring pads out of sight
- (2) pair of 45-degree LD pivot hinges



For video visit:
rev-a-shelf.com/videos

**Insert 11 for White finish or 15 for Almond finish

(2) Slim Series Tip-Out Trays w/ End Caps & (2) pr. of Hinges

PRODUCT	DESCRIPTION	DIMS	FINISH	SLP
6542-11-**-52	Tip-Out Tray w/ Hinges	11" (280 mm) W x 1-11/16" (42 mm) D x 3-15/16" (100 mm) H	Polymer	\$38.70
6542-14-**-52	Tip-Out Tray w/ Hinges	14" (360 mm) W x 1-11/16" (42 mm) D x 3-15/16" (100 mm) H	Polymer	\$38.85

(20) Two-Tray Sets w/ (40) Hinges & End Caps

6542-11-**-4	Tip-Out Trays w/ Hinges	11" (280 mm) W x 1-11/16" (42 mm) D x 3-15/16" (100 mm) H	Polymer	\$37.25 ea.
6542-14-**-4	Tip-Out Trays w/ Hinges	14" (360 mm) W x 1-11/16" (42 mm) D x 3-15/16" (100 mm) H	Polymer	\$38.00 ea.

Kits and Components

6541-36-**-52	Tray, End Caps, 2 pr. Hinges	36" (914 mm) W x 1-11/16" (42 mm) D x 3-15/16" (100 mm) H	Polymer	\$49.45
6541-36-**-50	Tray, End Caps, 1 pr. Hinges	36" (914 mm) W x 1-11/16" (42 mm) D x 3-15/16" (100 mm) H	Polymer	\$34.35
6541-36-**-ETH	Tray, End Caps, 1 pr. Hinges	36" (914 mm) W x 1-11/16" (42 mm) D x 3-15/16" (100 mm) H	Polymer	\$49.45

Bulk Components

6541-36-**-4	(20) Trays only	36" (914 mm) W x 1-11/16" (42 mm) D x 3-15/16" (100 mm) H	Polymer	\$19.00 ea.
6542-97-**-4	(40) Hinges & End Caps Sets		Polymer	\$19.00 ea.
6542-ETH-**-10	(10) Hinges & End Caps Sets		Polymer	\$28.55 ea.

Waste
Blind Corner
Sink
Base
Tall
Drawer
Wall
Vanity
Closet
Susan
Lazy
LED Lighting

65**/6581 Series

Tip-Out Tray Sets w/ Soft-Close



SCAN FOR PRICING!



- 25", 28", 31" and 36" trays, almond, white or stainless steel
- Soft-close hinges
- Only 3/4" clearance on either side needed for use
- 50-degree opening
- Stiffening ribs provide extra stability and eliminate side play
- Easy installation
- US Patent No. 7,635,171
- US Patent No. 20,120,260,461A



6581-31SC-52



For video visit:
rev-a-shelf.com/videos



6541-36SC-11-50
Slim Sink Front Tip-Out Tray
w/ Soft-Close Hinges
(White finish shown)



6551-36SC-11-50
Sink Front Tip-Out Tray
w/ Soft-Close Hinges
(Almond finish shown)

NOTE: To order stainless steel trays with TABS 3-1/4" (83 mm) D order 6591-**-6 (Call for pricing).

Polymer Slim Series Sink Front Tip-Out Tray System w/ Soft-Close

PRODUCT	DESCRIPTION	FINISH	SLP
6541-36SC-11-50	36" Tray 36" (914 mm) W x 1-11/16" (43 mm) D x 3-15/16" (100 mm) H	White	\$46.55
6541-36SC-15-50	36" Tray 36" (914 mm) W x 1-11/16" (43 mm) D x 3-15/16" (100 mm) H	Almond	\$46.55

Polymer Tip-Out Trays w/ Soft-Close Hinges

6551-36SC-11-50	36" Tray 36" (914 mm) W x 2-7/16" (62 mm) D x 3-15/16" (100 mm) H	White	\$49.60
6551-36SC-15-50	36" Tray 36" (914 mm) W x 2-7/16" (62 mm) D x 3-15/16" (100 mm) H	Almond	\$50.60

Stainless Steel Tip-Out Trays w/ Soft-Close Hinges

6581-25SC-52	25" Stainless Steel Tray 25" (635 mm) W x 2-1/8" (54 mm) D x 3" (76 mm) H	Stainless Steel	\$63.50
6581-28SC-52	28" Stainless Steel Tray 28" (711 mm) W x 2-1/8" (54 mm) D x 3" (76 mm) H	Stainless Steel	\$68.90
6581-31SC-52	31" Stainless Steel Tray 31" (787 mm) W x 2-1/8" (54 mm) D x 3" (76 mm) H	Stainless Steel	\$71.90



SCAN FOR PRICING!

Stainless Steel Tip-Out Tray Sets

65** Series



- 10" to 31" trays, stainless steel
- Designed to accommodate minimum clearance openings for large sink applications
- Compatible with Rev-A-Shelf's patented Self-Holdin® hinges (sold separately) (US Patent No. 7,635,171)
- Custom logo or trade name stamping also available (80 tray minimum plus die cost)

NOTE: * Insert "8" for a 2-1/8" Deep Tray or a "4" for a Slim Series, 1-11/16". Ex. 6541-10-4 or 6581-10-4
 - To order INDIVIDUAL packed trays with (1) pair of hinges, apply the same depth notation (4 or 8) and change the last sequence of numbers to -52. Ex. 6541-10-52 or 6581-10-52. (Call for pricing)
 US PATENT NO: 7,635,171

(20) Stainless Steel Trays w/ (20 pr.) Hinges

PRODUCT	DESCRIPTION	DIMS	FINISH	SLP
65*1-10-4	10" Tip-Out Tray Sets	10" (254 mm) W x See Note for Depth x 3" (77 mm) H	Stainless Steel	\$32.75 ea.
65*1-11-4	11-1/4" Tip-Out Tray Sets	11-1/4" (286 mm) W x See Note for Depth x 3" (77 mm) H	Stainless Steel	\$33.20 ea.
65*1-13-4	13" Tip-Out Tray Sets	13" (330 mm) W x See Note for Depth x 3" (77 mm) H	Stainless Steel	\$33.50 ea.
65*1-14-4	14-1/4" Tip-Out Tray Sets	14-1/4" (362 mm) W x See Note for Depth x 3" (77 mm) H	Stainless Steel	\$34.35 ea.
65*1-16-4	16" Tip-Out Tray Sets	16" (407 mm) W x See Note for Depth x 3" (77 mm) H	Stainless Steel	\$34.65 ea.
65*1-19-4	19" Tip-Out Tray Sets	19" (483 mm) W x See Note for Depth x 3" (77 mm) H	Stainless Steel	\$35.50 ea.
65*1-22-4	22" Tip-Out Tray Sets	22" (559 mm) W x See Note for Depth x 3" (77 mm) H	Stainless Steel	\$37.55 ea.
65*1-25-4	25" Tip-Out Tray Sets	25" (635 mm) W x See Note for Depth x 3" (77 mm) H	Stainless Steel	\$39.60 ea.
65*1-28-4	28" Tip-Out Tray Sets	28" (711 mm) W x See Note for Depth x 3" (77 mm) H	Stainless Steel	\$40.45 ea.
65*1-31-4	31" Tip-Out Tray Sets	31" (788 mm) W x See Note for Depth x 3" (77 mm) H	Stainless Steel	\$41.45 ea.

(20) Stainless Steel Trays Only

65*1-10-5	10" Tip-Out Tray	10" (254 mm) W x See Note for Depth x 3" (77 mm) H	Stainless Steel	\$21.00 ea.
65*1-11-5	11-1/4" Tip-Out Tray	11-1/4" (286 mm) W x See Note for Depth x 3" (77 mm) H	Stainless Steel	\$21.60 ea.
65*1-13-5	13" Tip-Out Tray	13" (330 mm) W x See Note for Depth x 3" (77 mm) H	Stainless Steel	\$22.05 ea.
65*1-14-5	14-1/4" Tip-Out Tray	14-1/4" (362 mm) W x See Note for Depth x 3" (77 mm) H	Stainless Steel	\$22.35 ea.
65*1-16-5	16" Tip-Out Tray	16" (407 mm) W x See Note for Depth x 3" (77 mm) H	Stainless Steel	\$22.35 ea.
65*1-19-5	19" Tip-Out Tray	19" (483 mm) W x See Note for Depth x 3" (77 mm) H	Stainless Steel	\$23.95 ea.
65*1-22-5	22" Tip-Out Tray	22" (559 mm) W x See Note for Depth x 3" (77 mm) H	Stainless Steel	\$25.80 ea.
65*1-25-5	25" Tip-Out Tray	25" (635 mm) W x See Note for Depth x 3" (77 mm) H	Stainless Steel	\$28.00 ea.
65*1-28-5	28" Tip-Out Tray	28" (711 mm) W x See Note for Depth x 3" (77 mm) H	Stainless Steel	\$29.60 ea.
65*1-31-5	31" Tip-Out Tray	31" (788 mm) W x See Note for Depth x 3" (77 mm) H	Stainless Steel	\$31.45 ea.

(20) Stainless Steel Tray w/ Tabs

6591-10-6	10" Tip-Out Trays	11" (279 mm) W x 3-1/8" (79 mm) D x 3" (76 mm) H	Stainless Steel	\$24.95 ea.
6591-11-6	11-1/4" Tip-Out Trays	12" (305 mm) W x 3-1/8" (79 mm) D x 3" (76 mm) H	Stainless Steel	\$25.25 ea.
6591-13-6	13" Tip-Out Trays	14" (356 mm) W x 3-1/8" (79 mm) D x 3" (76 mm) H	Stainless Steel	\$25.65 ea.
6591-14-6	14-1/4" Tip-Out Trays	15" (381 mm) W x 3-1/8" (79 mm) D x 3" (76 mm) H	Stainless Steel	\$26.10 ea.
6591-16-6	16" Tip-Out Trays	17" (432 mm) W x 3-1/8" (79 mm) D x 3" (76 mm) H	Stainless Steel	\$26.70 ea.
6591-19-6	19" Tip-Out Trays	20" (508 mm) W x 3-1/8" (79 mm) D x 3" (76 mm) H	Stainless Steel	\$28.70 ea.
6591-22-6	22" Tip-Out Trays	23" (584 mm) W x 3-1/8" (79 mm) D x 3" (76 mm) H	Stainless Steel	\$30.30 ea.
6591-25-6	25" Tip-Out Trays	26" (660 mm) W x 3-1/8" (79 mm) D x 3" (76 mm) H	Stainless Steel	\$33.20 ea.
6591-28-6	28" Tip-Out Trays	29" (737 mm) W x 3-1/8" (79 mm) D x 3" (76 mm) H	Stainless Steel	\$34.95 ea.
6591-31-6	31" Tip-Out Trays	32" (813 mm) W x 3-1/8" (79 mm) D x 3" (76 mm) H	Stainless Steel	\$35.65 ea.

Waste
Blind Corner
Sink
Base
Tall
Drawer
Wall
Vanity
Closet
Susan
LED Lighting

LD-0220 Series

Soft-Close Pivot Hinge



SCAN FOR PRICING!

- 50-degree opening
- Soft-close hinge
- Stiffening ribs provide extra stability and eliminate side play
- (US Patent No. 7,635,171)
- (US Patent No. 20,120,260,461A)

LD-0220-50SC-40

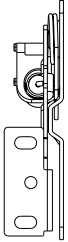

SOFT-CLOSE TIP-OUT HINGE

LD-0220-50SCFO-40

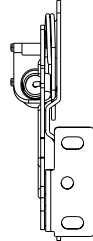

SOFT-CLOSE TIP-OUT HINGE FOR FULL OVERLAY DOOR

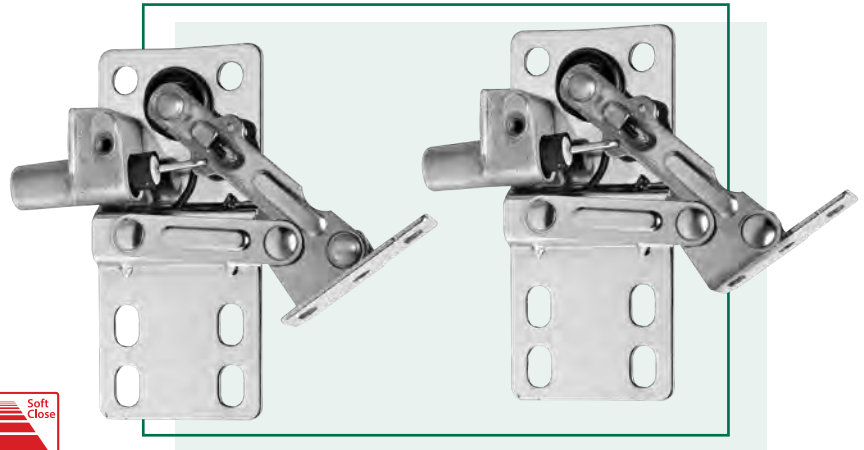

LD-0220-50SC-40

LD-0220-50SCFO-40

(40 pr.) Pivot Hinge w/ Soft-Close

PRODUCT	DESCRIPTION	DIMS	FINISH	SLP
LD-0220-50SC-40	Tip-Out Hinge	1" (26 mm) W x 2-5/8" (67 mm) D x 3-7/8" (99 mm) H	Silver	\$29.60 pr.
LD-0220-50SCFO-40	Tip-Out Hinge for Full Overlay	1-1/4" (32 mm) W x 2-5/8" (67 mm) D x 3-7/8" (99 mm) H	Silver	\$32.65 pr.

LD-0220 Series

Pivot Hinge

- 45-degree opening
- Face frame or full access compatible
- Spring design closes firmly and stays closed
- Stiffening ribs provide extra stability
- (US Patent No. 7,635,171)

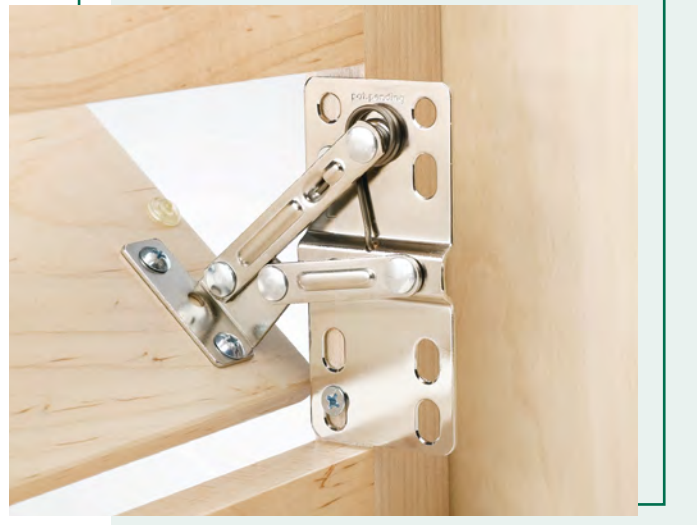

LD-0220-45-40

(40 pr.) Pivot Hinge

PRODUCT	DESCRIPTION	DIMS	FINISH	SLP
LD-0220-45-40	45-degree Pivot Hinge	1" (26 mm) W x 1-3/4" (45 mm) D x 3-7/8" (99 mm) H	Silver	\$8.75 pr.



SCAN FOR PRICING!

Self-Holdin[®] Tip-Out Hinges

6552 Series

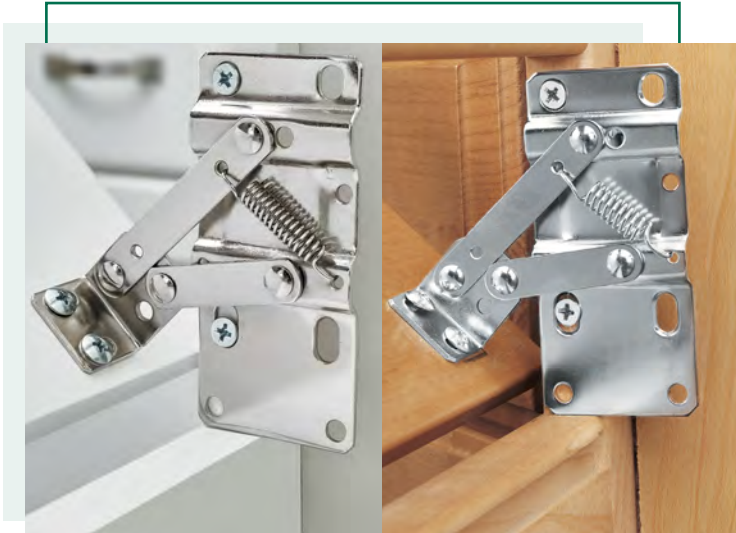

6552-94-0220-4

6552-95-0220-4

- Available in (2) different sizes
- Self-closing spring to keep false fronts securely closed

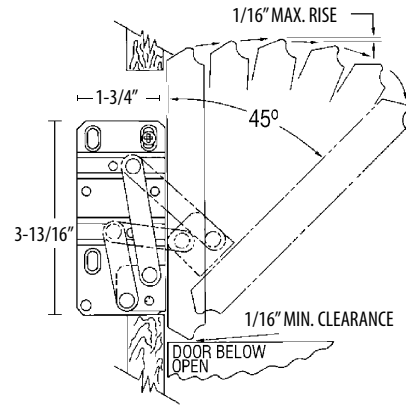

(40 pr.) Tip-Out (Self-Holdin[®]) Hinge

PRODUCT	DESCRIPTION	DIMS	FINISH	SLP
6552-94-0220-4	Hinges For Tip-Out Trays (under 16")	1" (26 mm) W x 1-3/4" (45 mm) D x 3-13/16" (97 mm) H	Silver	\$8.85 pr..
6552-95-0220-4	Hinges For Tip-Out Trays (16" and longer)	1" (26 mm) W x 1-3/4" (45 mm) D x 3-13/16" (97 mm) H	Silver	\$8.85 pr..

Euro Hinges

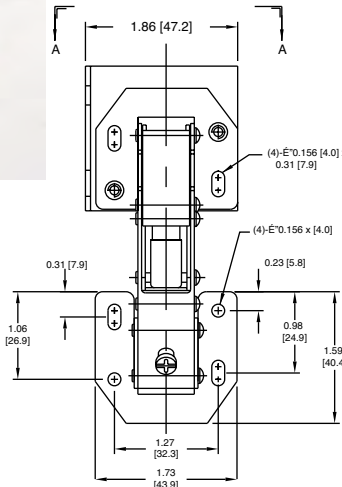

6552 Series

- Designed for long sink front false panels
- Adjustable opening of 45 to 90 degrees

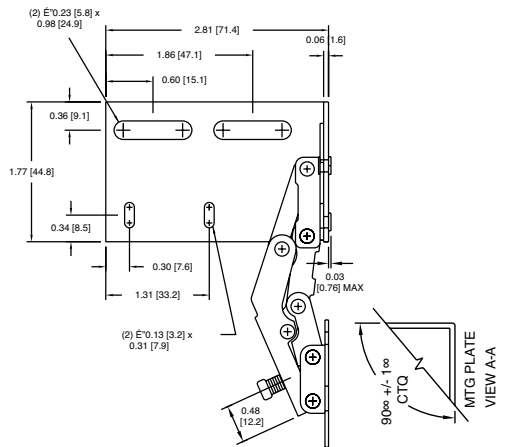

(10 pr.) Euro Hinges

PRODUCT	DESCRIPTION	DIMS	FINISH	SLP
6552-ETH-10	Euro Hinges	See Illustration Above	Silver	\$18.70 pr.

Waste
Blind Corner
Sink
Base
Tail
Drawer
Wall
Vanity
Closet
Susan
Lazy
Lighting
LED



SCAN FOR PRICING!

Waste
Blind Corner
Sink
Base
Tall
Drawer
Wall
Vanity
Closet
Lazy Susan
LED Lighting

- Designed for 30" sink base cabinets
- Chrome-plated wire L-shaped frame
- Mounts to cabinet side walls
- Universal mounting, non-handed hardware
- Fits around plumbing

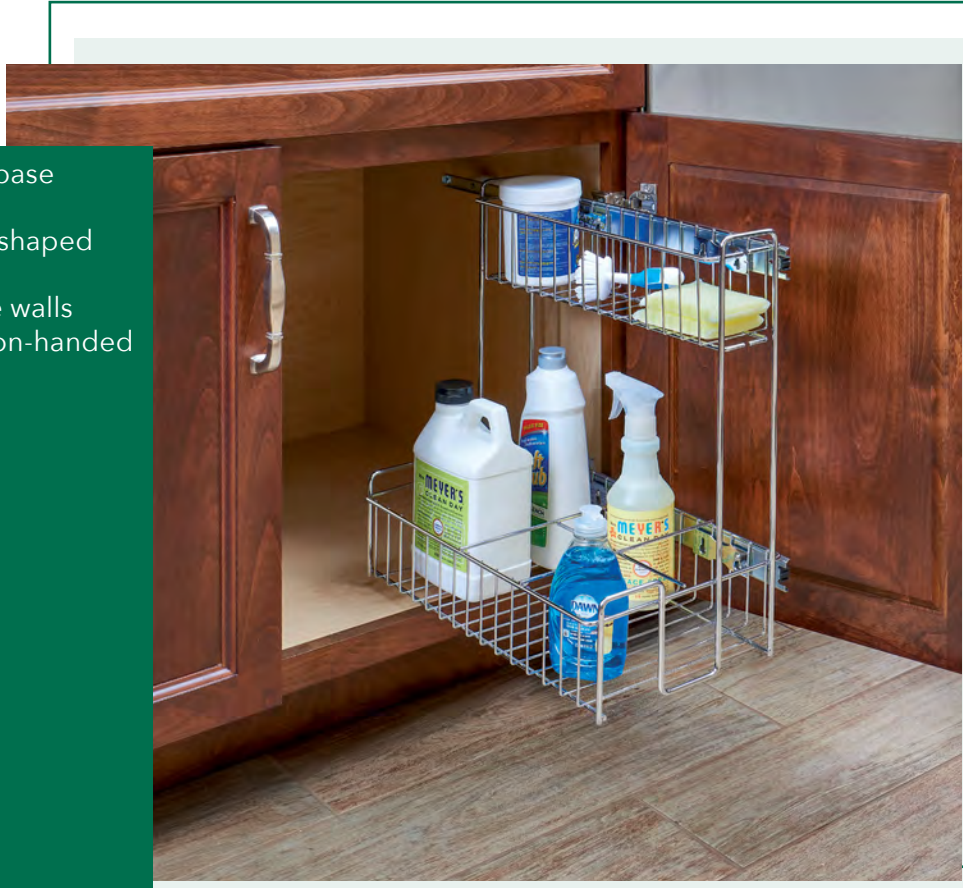

548-10CR-1
Sink Base Organizer

Sink Base Organizer							
PRODUCT	DESCRIPTION	DIMS	MCO	CAB	FINISH	SLP	
548-10CR-1	Sink Base Organizer	9-3/4" (248 mm) W x 16" (406 mm) D x 18" (457 mm) H	10" (254 mm)	SB30	Chrome	\$139.80	



SCAN FOR PRICING!

Sink Base Door Storage

4SBSU Series



4SBSU-15

- Designed for 30", 36" and 42" sink base cabinet doors
- Natural maple construction with semi-gloss finish
- Patented adjustable door mount brackets that provide up to 5" adjustability (US Patent No. 7,204,569)
- TSCA Title VI compliant

Sink Base Door Storage

PRODUCT	DESCRIPTION	DIMS	MCO	CAB	FINISH	SLP
4SBSU-15	Door Storage	10-1/2" (267 mm) W x 5" (127 mm) D x 18-1/2" (470 mm) H	11-5/8" (295 mm) - FF 10-5/8" (270 mm) - FL	SB30	Maple	\$108.60
4SBSU-18	Door Storage	13-1/2" (343 mm) W x 5" (127 mm) D x 18-1/2" (470 mm) H	14-3/8" (365 mm) - FF 13-5/8" (346 mm) - FL	SB36	Maple	\$129.35
4SBSU-21	Door Storage	16-1/2" (419 mm) W x 5" (127 mm) D x 18-1/2" (470 mm) H	17-1/4" (438 mm) - FF 16-5/8" (422 mm) - FL	SB42	Maple	\$146.45

Grocery Bag Holder

4SPBD Series



4SPBD-15

- Designed for 30" and 36" sink base cabinet doors
- Natural maple construction with semi-gloss finish
- Patented adjustable door mount brackets that provide up to 5" adjustability (US Patent No. 7,204,569)
- TSCA Title VI compliant

Sink Base Grocery Bag Door Storage

PRODUCT	DESCRIPTION	DIMS	MCO	CAB	FINISH	SLP
4SPBD-15	Grocery Bag Holder	10-1/2" (267 mm) W x 5" (127 mm) D x 18-5/8" (473 mm) H	11-5/8" (295 mm) - FF 10-5/8" (270 mm) - FL	SB30	Maple	\$128.45
4SPBD-18	Grocery Bag Holder	13-1/2" (343 mm) W x 5" (127 mm) D x 18-5/8" (473 mm) H	14-3/8" (365 mm) - FF 13-5/8" (346 mm) - FL	SB36	Maple	\$141.10

Waste
Blind Corner
Sink
Base
Tall
Drawer
Wall
Vanity
Closet
Susan
Lazy
LED
Lighting



SCAN FOR PRICING!

Waste
Blind Corner
Sink
Base
Tall
Drawer
Wall
Vanity
Closet
Lazy Susan
LED Lighting

- Designed for 30" sink base cabinets
- Chrome-plated wire frame
- (2) polymer bottom shelves
- 3/4" extension, Euro, 75 lb. rated slides
- Mounts to cabinet floor
- Universal mounting, non-handed hardware
- Bottom bumpers to protect countertop surfaces
- Removable caddy for convenience

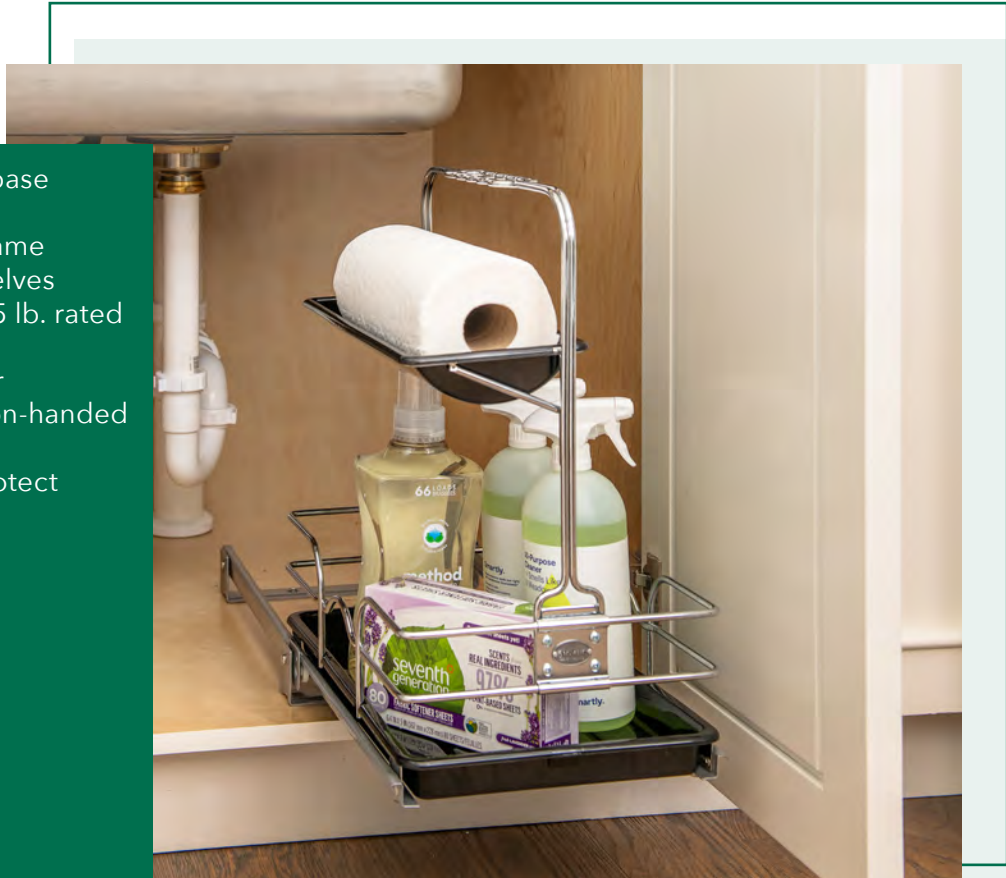

544-10C-1
Under Sink Cleaning Caddy



Removable caddy allows you to take cleaning items with you and the added bottom bumpers provide stability and protect surfaces from marring

Under Sink Cleaning Caddy

PRODUCT	DESCRIPTION	DIMS	MCO	CAB	FINISH	SLP
544-10C-1	Under Sink Cleaning Caddy	11-1/4" (286 mm) W x 16-1/4" (413 mm) D x 19-1/2" (495 mm) H	11-1/4" (286 mm) - FF 11-3/8" (289 mm) - FL	SB30	Chrome	\$135.00



Sink Base Waste Pullout

5SBWC Series

SCAN FOR PRICING!

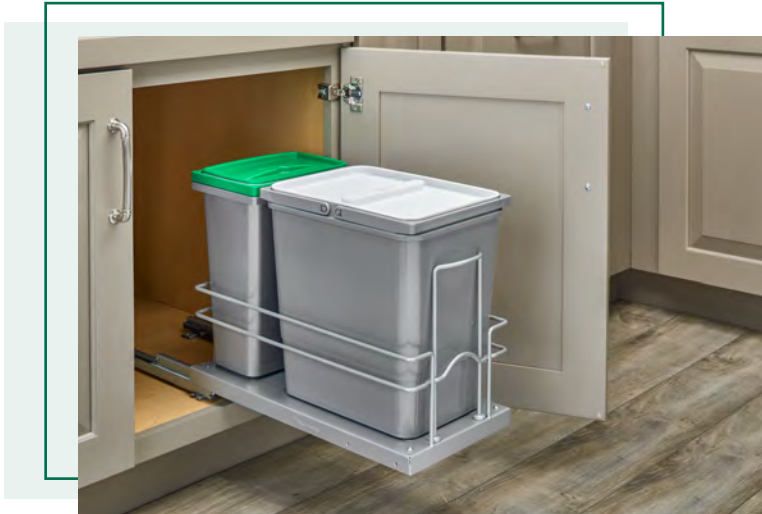

For video visit:
rev-a-shelf.com/videos

- Designed for 24" and larger sink base cabinets
- (1) 8 L and (1) 15 L bin, both with handles
- Full-extension, under mount, 75 lb. rated, concealed slides with soft-close
- Mounts to cabinet floor
- (1) green lid and (1) white lid
- Door mounting kit (sold separately)

Wire Under Sink Waste Pullout

PRODUCT	DESCRIPTION	DIMS	MCO	CAB	FINISH	SLP
5SBWC-815S-1	(1) 8 L and (1) 15 L	8-15/16" (211 mm) W x 18-19/32" (473 mm) D x 14-1/4" (362 mm) H	9" (229 mm)	SB24	Silver	\$189.65

Accessories

5WB-DMKIT	Door Mount Kit				Chrome	\$42.35
-----------	----------------	--	--	--	--------	---------

Waste & Cleaning Pullout

5SBWCC Series



For video visit:
rev-a-shelf.com/videos

- Designed for 24" and larger sink base cabinets
- (1) 8 L with removable rack and (2) 1 L spray bottles
- Full-extension, under mount, 75 lb. rated, concealed slides with soft-close
- Mounts to cabinet floor
- (1) green lid
- Door mounting kit (sold separately)

Wire Under Sink Waste & Cleaning Pullout

PRODUCT	DESCRIPTION	DIMS	MCO	CAB	FINISH	SLP
5SBWCC-8S-1	(1) 8 L and (2) 1 L Bottles	8-15/16" (227 mm) W x 18-19/32" (473 mm) D x 14-1/4" (362 mm) H	9" (229 mm)	SB24	Silver	\$157.90

Accessories

5WB-DMKIT	Door Mount Kit				Chrome	\$42.35
-----------	----------------	--	--	--	--------	---------

Waste
Blind Corner
Sink
Base
Tail
Drawer
Wall
Vanity
Closet
Susan
Lazy
LED
Lighting



SCAN FOR PRICING!



- Designed for 33" and 36" sink base cabinets
- U-shaped solid bottom shelves, natural maple, gray or orion gray
- Full-extension, BLUM soft-close undermount slides
- Mounts to cabinet floor or side walls
- Pre-assembled door mount brackets
- Side and bottom mount brackets
- Fits around plumbing
- TSCA Title VI compliant

(2) units shown 5386-33BCSCFL-FOG

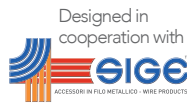

For video visit: rev-a-shelf.com/videos

Waste

Blind Corner

Sink

Base

Tall

Drawer

Wall

Vanity

Closet

Lazy Susan

LED Lighting



SCAN FOR PRICING!



Full-extension slides with soft-close



Can be side mounted

PART	Basket Width "W"
5386-30BCSC-**	28-15/16" (735 mm)
5386-33BCSC-**	31-15/16" (811 mm)
5386-30BCSCFL-FOG	28-15/16" (735 mm)
5386-33BCSCFL-FOG	31-15/16" (811 mm)

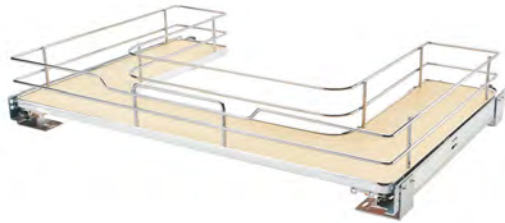

5386-30BCSC-MP
U-Shaped Solid Bottom Shelf
(Natural Maple finish shown)



5386-30BCSC-GR
U-Shaped Solid Bottom Shelf
(Gray finish shown)

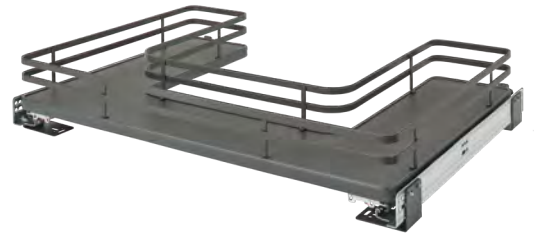

5386-30BCSCFL-FOG
U-Shaped Solid Bottom Shelf
(Orion Gray finish shown)

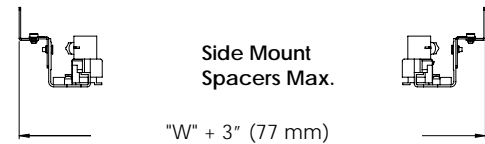
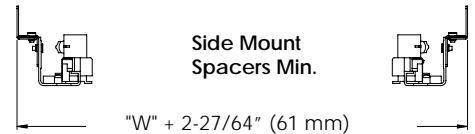
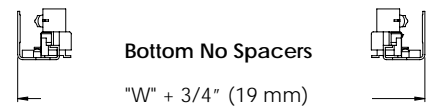
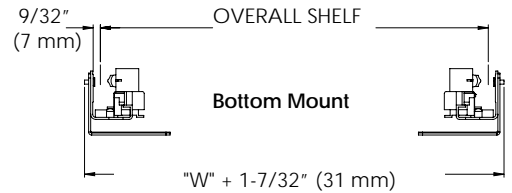

NOTE: ** Insert "MP" for Maple Shelf or "GR" for Gray Shelf

U-Shaped Solid Bottom Shelf w/ BLUMOTION Soft-Close

PRODUCT	DESCRIPTION	DIMS	MCO	CAB	FINISH	SLP
5386-30BCSC-**	Solid Bottom Shelf	29-11/16" (754 mm) - 32" (813 mm) W x 21-17/32" (547 mm) D x 5-1/16" (129 mm) H	29-11/16" (754 mm)	SB33	Chrome	\$457.20
5386-33BCSC-**	Solid Bottom Shelf	32-11/16" (830 mm) - 35" (889 mm) W x 21-17/32" (547 mm) D x 5-1/16" (129 mm) H	32-11/16" (830 mm)	SB36	Chrome	\$469.10

Full Access U-Shaped Solid Bottom Shelf w/ BLUMOTION Soft-Close

5386-30BCSCFL-FOG	Solid Bottom Shelf	29-11/16 - 32" (754 - 813 mm) W x 21-17/32" (551 mm) D x 5-1/16" (146 mm) H	29-11/16" (754 mm)	FLSB33	Orion Gray	\$611.05
5386-33BCSCFL-FOG	Solid Bottom Shelf	32-11/16 - 35" (830 - 889 mm) W x 21-17/32" (551 mm) D x 5-1/16" (146 mm) H	32-11/16" (830 mm)	FLSB36	Orion Gray	\$621.90

SCAN FOR
PRICING!

- Designed for 33" and 36" sink base cabinets
- U-shaped chrome wire bottom shelves
- Full-extension, ball-bearing slides with soft-close
- Mounts to cabinet floor or side walls
- Pre-assembled door mount brackets
- Side and bottom mount brackets
- Fits around plumbing



(2) units shown

5786-33CR

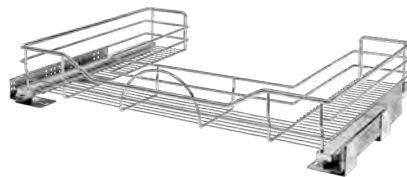
**5786-33CR**

U-Shaped Wire Bottom Shelf

Door mountable with included
door mount brackets**U-Shaped Wire Bottom Shelf w/ Ball-Bearing Soft-Close**

PRODUCT	DESCRIPTION	DIMS	MCO	CAB	FINISH	SLP
5786-30CR	Wire Bottom Shelf	29-3/8 - 31-3/4" (749 - 806 mm) W x 21-3/4" (556 mm) D x 5-5/16" (140 mm) H	29-3/8" (746 mm) - FF 29-3/8" (746 mm) - FL	SB33	Chrome	\$449.05
5786-33CR	Wire Bottom Shelf	32-3/8 - 34-3/4" (826 - 883 mm) W x 21-3/4" (556 mm) D x 5-5/16" (140 mm) H	32-3/8" (822 mm) - FF 32-3/8" (822 mm) - FL	SB36	Chrome	\$470.95



SCAN FOR PRICING!

Maple U-Shaped Vanity Pullout

486 Series



- Designed for 30" vanity sink base cabinets, but works great in standard depth cabinets as well
- Natural maple construction with semi-gloss finish
- Full-extension, BLUM soft-close undermount slides
- Mounts to cabinet floor or side walls
- Side and bottom mount brackets
- (4) adjustable dividers, (1) 8 L waste container w/ white lid (BM), (2) removable polycarbonate bins (SM)
- Non-skid vinyl lining
- TSCA Title VI compliant

486-30VSBSC-BM-1 (2) units shown



486-30VSBSC-BM-1
Maple U-Shaped Pullout
w/ (4) Adjustable Dividers and
(1) 8 qt. Container
(Bottom mount unit shown)



486-30VSBSC-SM-1
Maple U-Shaped Pullout
w/ (4) Adjustable Dividers and
(2) Acrylic Bins
(Side mount unit shown)



For video visit:
rev-a-shelf.com/videos

U-Shaped Vanity Pullout w/ BLUMOTION Soft-Close

PRODUCT	DESCRIPTION	DIMS	MCO	CAB	FINISH	SLP
486-30VSBSC-BM-1	Bottom Mount Pullout	25-5/8" (652 mm) W x 18-11/16" (475 mm) D x 14-1/4" (362 mm) H	25" (635 mm) - FF 25-3/4" (654 mm) - FL	VSB30	Maple	\$416.15
486-30VSBSC-SM-1	Side Mount Pullout	27-17/32 - 28-3/4" (700 - 730 mm) W x 19 - 20-3/4" (483 - 527 mm) D x 6-1/2" (165 mm) H	25" (635 mm) - FF 25" (635 mm) - FL	VSB30	Maple	\$388.00



SCAN FOR PRICING!



- Designed for 24" and 30" vanity sink base cabinets
- L-shaped natural maple dovetail frame with semi-gloss finish
- (4) shelves with non-skid vinyl lining on lower level
- Full-extension, BLUM soft-close undermount slides
- (6) polycarbonate bins for upper level
- Mounts to cabinet floor
- Patented design (US Patent No. D854,359)
- Patented mounting straps (US Patent No. 9,756,941)
- TSCA Title VI compliant



441-15VSBSC-1



441-12VSBSC-1
Vanity Organizer

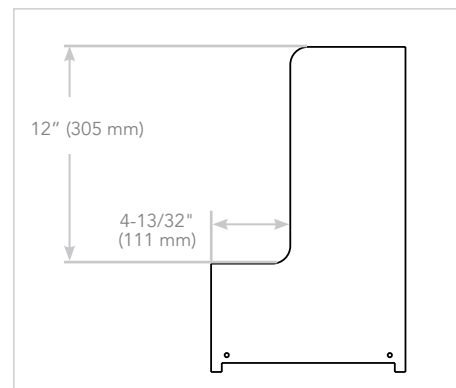

PIPE CLEARANCE DIMENSIONS
(For both units)



For video visit:
rev-a-shelf.com/videos

L-Shaped Vanity Organizers w/ BLUMOTION Soft-Close

PRODUCT	DESCRIPTION	DIMS	MCO	CAB	FINISH	SLP
441-12VSBSC-1	Vanity Organizer	8-1/2" (216 mm) W x 18-25/32" (477 mm) D x 18-27/32" (479 mm) H	9" (229 mm)	VS24	Maple	\$410.35
441-15VSBSC-1	Vanity Organizer	11-21/32" (291 mm) W x 18-25/32" (477 mm) D x 18-27/32" (479 mm) H	12" (305 mm)	VS30	Maple	\$511.00